

LIGHTHOUSE REPORTS

Battery Fire Safety Ventilation for Fully Electrical Vessel



**Ett innovationsprojekt utfört inom Trafikverkets
branschprogram Hållbarsjöfart som drivs av Lighthouse.
Publicerad September 2023**

Battery Fire Safety Ventilation for Fully Electrical Vessel

Development of a battery fire safety concept addressing ventilation of battery room onboard

Authors

Vasudev Ramachandra, Anna Karlsson, Ola Willstrand and Mikael Hägg (RISE Research Institutes of Sweden AB)

Martin Schreuder (Chalmers University of Technology)

In cooperation with

Corvus, ABB, Echandia, Trident BMC, Consilium Safety, Stena Teknik, ForSea, Wallenius Marine, Destination Gotland, Swedish Transport Agency, and DNV.

An innovation project carried out within the Swedish Transport Administration's industry program Sustainable Shipping, operated by Lighthouse.

Summary

The project "Battery Fire Safety Ventilation for Fully Electrical Vessel" is a follow-up project to the previous project "Electric Light", both carried out within the Swedish Transport Administration's industry program Sustainable Shipping. The objective of the project is to develop ventilation concepts and post-fire strategies for fully electric Ro-Pax ships (roll-on/roll-off passenger ships) for international voyages. The project aims to develop design guidelines for ventilation system concepts, considering the management of thermal runaway scenarios. It also seeks to initiate a strategy for changing ventilation rates based on different fire suppression and ventilation concepts. Additionally, the project aims to develop strategy for purging battery rooms that may contain flammable gases and for removing damaged batteries from the battery room in the ship's bottom deck. The project acknowledges that regulations regarding battery installations and safety on board vessels are still developing. Classification societies such as DNV, Bureau Veritas, and Lloyd's Register are working on rules and recommendations, but they are currently vastly subjective and qualitative in nature. This project aims to improve quantitative definitions, requirements, and procedures to further enhance existing and future regulations.

The project methodology involves close cooperation with industry partners, regulatory bodies, and experts in battery safety, electrical engineering, fire safety, and ship design. Workshops, focus discussions, and regular meetings have been conducted to gather input, discuss ventilation design concepts, and address regulatory aspects. The project has also considered different battery chemistries and their safety aspects. The project outcomes revealed deficiencies in battery room ventilation design, regulation, and operation. The general concept emphasized the importance of off-gas ducts and propagation safety within battery modules for optimal ventilation design. Overall, the project aimed to address these issues and provide ventilation solutions for different scenarios to ensure safety in a fully electric Ro-Pax ship.

Sammanfattning

Projektet "Battery Fire Safety Ventilation for Fully Electrical Vessel" är ett uppföljningsprojekt till det tidigare projektet "Lätta Elfartyg" vilka båda genomförts inom Trafikverkets branschprogram Hållbar sjöfart. Målet med projektet är att utveckla ventilationskoncept och åtgärdsstrategier efter brand, för helt elektriska Ro-Pax-fartyg (roll-on/roll-off passagerarfartyg) som opererar internationellt. Projektet syftar till att utveckla designriktlinjer för ventilationskoncept, med hänsyn till hanteringen av termisk rusning. Projektet syftar också till att initiera en strategi för att ändra ventilationshastigheter baserat på olika brandsläcknings- och ventilationskoncept. Dessutom syftar projektet till att utveckla strategier för att rena batterirum som kan innehålla brandfarliga gaser och för att ta bort skadade batterier från batterirummet som är placerat på däck 1, fartygets lägsta däck. Projektet konstaterar att reglerna för batteriinstallationer och säkerhet ombord på fartyg fortfarande är under utveckling. Klassningssällskap som DNV, Bureau Veritas och Lloyd's Register arbetar med föreskrifter och rekommendationer, men de är för närvarande mycket subjektiva och kvalitativa till sin natur. Detta projekt syftar till att förbättra kvantitativa definitioner, krav och procedurer för att ytterligare förbättra befintliga och framtida regler.

Projektet har utförts i nära samarbete med industripartners, tillsynsorgan och experter inom batterisäkerhet, elteknik, brandsäkerhet och fartygsdesign. Workshops, fokusdiskussioner och regelbundna möten har genomförts för att samla in synpunkter, diskutera koncept för ventilationsdesign och ta upp regulatoriska aspekter. Projektet har också beaktat olika batterikemier och deras säkerhetsaspekter. Projektets resultat avslöjade brister i design, reglering och drift av batterirumsventilation. Det framarbetade ventilationskonceptet betonar vikten av avgaskanaler för gaser från termisk rusning, och säkerhetsbarriärer för propagering inom batterimoduler för optimal ventilationsdesign. Sammantaget syftade projektet till att ta itu med dessa frågor och tillhandahålla ventilationslösningar för olika scenarier för att säkerställa säkerheten för ett batterirum på ett helelektrisk Ro-Pax-fartyg.

Content

1	Introduction	5
1.1	Purpose of the study.....	5
1.2	More about the work in Electric Light.....	6
1.3	Regulations.....	7
2	Methodology.....	8
2.1	Workshops.....	8
2.2	Focus discussions	10
2.3	Development of ventilation concept	10
3	Battery system.....	10
3.1	Battery chemistries	10
3.2	Battery configuration.....	11
4	Past battery accidents.....	13
4.1	MF Ytterøyningen, 2019.....	13
4.2	MF Brim Explorer, 2021	14
4.3	Fire at McMicken Battery Energy Storage System (Arizona), 2019	15
5	Project outcomes	16
5.1	A view of present shortfalls in battery room ventilation	16
5.2	Result from workshops and focus discussions	17
5.3	General concept.....	17
5.4	Casualty unit	19
5.5	Ventilation modes	20
5.6	Ventilation calculation.....	23
5.7	Design of battery room ventilation	25
5.8	Post fire/emergency strategies	29
5.9	Relevance of battery chemistry and battery size.....	30
6	Conclusions.....	32
7	References	33
8	Appendices.....	34
	Appendix 1 – Workshop results	35
	Appendix 2 – General arrangement Electric Light.....	42

1 Introduction

There is a worldwide demand to reduce emissions of greenhouse gases. It will require large efforts, both energy efficiency measures for existing ships and new concepts for fossil-free ships to meet the International Maritime Organization (IMO) emissions objective of 50% reduction of greenhouse gases (GHG) from shipping by 2050 according to the Initial IMO GHG Strategy [1]. This strategy has been revised and the latest version was adopted in July 2023; the new IMO GHG Strategy is to reach net zero from international shipping by, or around, the year 2050 [2].

The revised IMO GHG Strategy includes an enhanced common ambition to reach net-zero GHG emissions from international shipping close to 2050, a commitment to ensure an uptake of alternative zero and near-zero GHG fuels by 2030, as well as indicative checkpoints for 2030 and 2040.

Electrical propulsion for small ships has been discussed for a long time and many installations are today operational. An overview can be found in [3]. Large battery installations on ships with long range is still an area in need for research and innovation. In the previous project named *Electric Light*, in the Sustainable Shipping program operated by Lighthouse, it was concluded that a fully electric ro-ro passenger (Ro-Pax) ship operating on a route from Sweden to Denmark (Gothenburg to Frederikshavn) is both a technically and viable realistic alternative [4]. The project *Electric Light* led to a novel ship design concept as a fully electric ship storing all the required energy in batteries in the bottom of the ship. Based on risk analyses of the design, a battery fire safety concept was established for the battery room, intended to be used as basis for the development of harmonized IMO regulations or guidelines. This process has been initiated through contacts with several Flag States and through discussions with Swedish Transport Agency and European Maritime Safety Agency (EMSA). The risk analyses also identified critical open questions relating to the ventilation system and explosion protection. [4]

Electric propulsion can be one solution towards reduction of GHG and there is a need for further investigation to support future implementation of fossil free propulsion using batteries for large vessels.

This project *Battery Fire Safety Ventilation for Fully Electrical Vessels* is a direct follow-up project to the *Electric Light* [4], where some critical design issues were identified for future work, and one of them was the ventilation concept and post-fire strategies.

1.1 Purpose of the study

The objective of this project is to take a step forward to develop a fully electric Ro-Pax ship for international voyage by further studying details of a ventilation concept, and post-fire strategies. The goal is to further and, in more detail, develop the battery fire safety concept proposal, including the development of

- A. Design guidelines for ventilation system concepts, with consideration to management of thermal runaway scenarios.
- B. Strategy for change in ventilation rates with consideration to different fire suppression concepts and different ventilation concepts.

- C. Strategy for purging of battery rooms containing potentially flammable gases, with consideration to ventilation concepts.
- D. Strategy for how damaged batteries, in the best way, should be removed from the bottom of the ship.

1.2 More about the work in Electric Light

In the previous project named *Electric Light*, in the Sustainable Shipping program operated by Lighthouse, the objective was to establish an innovative ship concept for a fully electric Ro-Pax ship, which makes use of new technology, especially in the area of electrical propulsion and energy storage. The project was conducted in cooperation with the industrial partners Stena Rederi AB, Wallenius Marine AB, and ABB Marine AB. The project chose a dedicated use case as baseline for the operational requirements leading to a specific conceptual design. Hence, the results were tailored to this use case. Despite some limitations, however, several design conclusions are generic and can contribute to general conceptual design aspects of fully electric ships. An overall life cycle perspective was not included. [4]

The project concluded that a fully electric Ro-Pax ship operating on the route Gothenburg to Frederikshavn is technically and commercial realistic, however with a number of identified challenges. The amount of electric energy to be stored in batteries onboard was about ten times more than the current largest marine battery installations. The project conducted a design of a novel ship concept including a new vehicle deck layout utilizing the possibilities a fully electric ship can provide regarding reduction and rearrangement of the machinery compartment. This has resulted in a 15% shorter ship with maintained cargo capacity compared to a conventional ship. By removing all combustion engines from the design, a significant number of supporting systems was also removed or simplified. A novel electric distribution system, pushing the boundaries of DC grid capacity giving an overall electrical system efficiency higher than the AC system at about 87% and a lower overall weight, has been suggested. [4]

The Electric Light ship concept is illustrated in Figure 1 below.



Figure 1 Ship concept *Electric Light* for a fully electrical Ro-Pax ferry [4]

The battery fire safety concept developed in *Electric Light* constitutes safety requirement guidelines for large ship battery installations and is one of the main results from the conducted risk analysis. An important conclusion related to a specific hazard in ship battery applications was that sea water intrusion in the battery space can be managed. [4]

The design of a fully electric ship with the specified capacities is a huge design undertaking where boundaries of the existing technologies will have to be moved. Three specific areas were identified as specifically challenging:

- Arrangement of battery banks including ventilation of battery spaces, which is addressed by this current project.
- New technology for efficient heating and cooling. One consequence of the higher efficiency of a fully electric ship is that less waste energy is available for heating.
- The main bottleneck for introducing fully electric ships is the shore-to-ship charging capacity.

A fully electric ship will be more expensive to build due to the cost of the batteries, which will be roughly one third of the costs of the ship. However, absence of combustion engines will save some cost and weight. The major benefit with a fully electrified ship is of course the almost complete elimination of emissions from the operation of the ship. The reduction in GHG emissions can be in the range of 25 000 tons per year, if a conventional diesel driven ship is replaced by a fully electric ship running on fossil free electricity. [4]

1.3 Regulations

With increase in interest within electrification of boats and ferries, there has also been some changes and additions with respect to rules and regulations. However, technology and implementation have been a few steps ahead of the this. It has majorly been the classification societies that are currently developing regulations and recommendations regarding battery installations and related safety on board vessels. Existing regulations published by DNV-GL¹, Bureau Veritas (BV) and Lloyds Register (LR) were considered for this project and studied as part of the literature study. Besides classification society, EMSA has ongoing work with producing guidance on the safety of battery energy storage systems onboard ships. Both RISE and the Swedish Transport Agency is involved in that work group.

It is evident that the regulations are improving and are still vastly subjective. For instance, resorting to a risk analysis as a justification to imply safety is suggested very often. It is often so that the recommendations or regulations are qualitative in nature and not quantitative. This also extends to procedures and not just hardware or installation. This project aims to quantify certain definitions, requirements and procedures which may be used to further the existing regulations.

¹ On March 1 2021, DNV GL became DNV.

2 Methodology

The project has been organised and performed in close cooperation with industry partners (battery system suppliers, ship operators, marine system integrators, heating, ventilation, and air conditioning (HVAC) consultants) and regulatory bodies (class and authorities/flag state). The project has been carried out with regular meetings with the project group (RISE and Chalmers), workshops and focus discussions including industry partners and regulatory bodies. RISE has used their competencies and expertise in battery safety, electrical engineering, and fire safety onboard vessels. Chalmers has used their competencies in ship design and structural aspects. Risk perspectives has been discussed throughout the project.

Workshops and focus discussions have involved the project group and relevant invited external parties. These are further explained in the following sections. After reporting the project in a public report, an open webinar to present the project results is planned. A schematic workflow of the project is illustrated in Figure 2.



Figure 2. Illustration of workflow in the project.

2.1 Workshops

Two workshops were carried out in the project. A starting workshop and a final workshop.

The first workshop had the objective to involve industry to discuss and elaborate on ventilation design concepts by addressing:

- Shortfalls in implementing battery systems on board today.
- Management of different scenarios (e.g., thermal runaway, post-fire).
- Design of ventilation systems for battery rooms.
- Removal of damaged batteries.
- Other, for participants, related issues.

This workshop included battery manufacturers, ventilation designers and ship operators. Background information was sent out before the workshop together with questions for the participants to prepare for, see Figure 3.

Please prepare to think through your view of battery installations, what are the shortfalls considering regulation; design; operation, organisation? Use this table to fill in in advance:

Design	Regulation	Operation	Organisation

Figure 3. Preparation questions sent out to the participants of the starting workshop.

Table 1 shows the scenarios discussed during the workshop. Results from this first workshop are found in *Appendix 1 – Workshop results* and reported in section 5.2.

Table 1. Scenarios and aspects that was discussed during workshop 1.

Scenario	Design of ventilation (piping, fans, capacity etc)	Handling of ventilation system	Purging of flammable/hazardous gases, emergency handling	Technical strategies after accident	Comments, pros/cons etc.
Normal operation					
Thermal runaway					
Saltwater ingress					

The second workshop was the final workshop before the reporting took place. For this workshop no background information was sent out but all participants had been part in a focus discussion prior to this final workshop. The final workshop had the objective to:

- Present the work conducted, the learnings and the concepts,
- Have room for questions and answers, and
- Get feedback from involved stakeholders.

Results from this second workshop is found in section 5.2.

2.2 Focus discussions

After the first workshop, three focus discussions was held with the following focuses respectively:

1. Setting the base for the ventilation concept
2. Looking into regulatory aspects
3. Getting the operator's view

Focus discussion 1 had the aim to identify 2-4 base design concepts in terms of

- Ventilation solution
- System design
- Battery chemistry/type

For this discussion, battery manufacturers together with ventilation designers and detection experts participated.

Focus discussion 2 had the aim to understand and discuss battery room design in terms of regulatory issues regarding ventilation (room ventilation and off-gas ventilation).

For this discussion representatives from classification society and authority participated.

Focus discussion 3 had the aim to get the operators view on:

- Battery ventilation with regard to ship operation and design,
- Management of battery and room ventilation, and
- Post emergency strategies.

For this discussion representatives from four different shipowners participated.

2.3 Development of ventilation concept

The result from the first workshop was feed into each focus discussion, as well as that each focus discussion was followed up by the project group; in meetings and further analyses. The result from each focus discussion thus led the project further in the process of developing a ventilation concept for a battery room on a fully electric Ro-Pax ship.

3 Battery system

This chapter introduce battery chemistries and their safety aspects. Also, the battery configuration used in this project is introduced.

3.1 Battery chemistries

The lithium (Li)-ion battery and its high energy density have been the enabler for electric propulsion in various applications. The results and discussions in this project assume that the Li-ion battery technology that is commercially available today is used. For sure, in certain applications, less energy dense technologies may also be an alternative, e.g., NiMH, NiCd and Lead-Acid. In addition, there are upcoming

technologies that may also be used in near future, e.g., solid-state lithium-ion batteries with increased energy density, as well as sodium-ion batteries which are slightly less energy dense but which, e.g., are using more earth abundant materials.

The Li-ion battery family is large, and there are several types that are commercially available today. Three main types, which are relevant for the maritime industry and relevant for the discussion on safety aspects, are discussed in this report. These are Ni-based, LFP (lithium iron phosphate), and LTO (lithium titanate oxide) type lithium-ion cells.

Nickel (Ni)-based cells have a lithium and nickel containing oxide cathode material which typically also include manganese and cobalt (NMC) or aluminium and cobalt (NCA) or a combination of the two. The ratio of the different components differs between cells which also affects the cell characteristics. Safety implications are discussed further in section 5.9. The anode is usually graphite, but today it can also be a mixture of graphite and silicon. With silicon the capacity can be increased, but the trade-off is larger volume changes during charging and discharging. The nominal cell voltage is around 3.7 V.

LFP cells have lithium iron phosphate (LiFePO_4) as the cathode material. The voltage versus graphite is lower (nominal voltage typically 3.2 V) why the energy density becomes lower as compared to Ni-based type. The LFP material is more thermally stable why these cells typically have less violent thermal runaway and reaches lower maximum temperature [5].

Finally, the LTO type cells use lithium titanate oxide as the anode material instead of graphite but uses typically the same Ni-based cathode material as in the Ni-based type cells (e.g., NMC). The potential of LTO is much higher than graphite why the cell nominal voltage typically become 2.4 V, which affects the energy density negatively. The advantage is that the electrolyte is stable within this voltage range, resulting in a more thermally stable cell. When graphite is used, some of the electrolyte decompose during the first cycle creating the solid electrolyte interface (SEI) on the graphite which stabilize the cell (within specified temperature range).

Not mentioned so far is, e.g., LMO (lithium manganese oxide) and LCO (lithium cobalt oxide) cathodes which do not contain nickel, but from a safety perspective these are less different to the Ni-based types as compared to LFP and LTO type. In the end, many cell parameters affect the overall safety performance and each specific cell type must be characterized before use in an onboard installation.

The electrolyte in all these Li-ion batteries is an organic solvent with lithium-salt.

3.2 Battery configuration

Battery configurations varies very vastly between ferries using battery power, and this includes both mechanical and electrical aspects. Different operational voltage levels, different stored energy levels, different capacities and cell chemistries, various physical design solutions, and different cooling methods are some of the many differences that can be observed. While factors like energy storage, voltage level, and other parameters

can be configured to suit the requirement, certain other factors are proprietary to the battery suppliers. These might include the physical dimensions of modules, method of stacking them on racks, off-gas venting mechanisms, cooling mechanisms etc.

As a basis for discussion and design in this report, the battery configuration from the project Electric Light [4] has been borrowed. The total capacity of energy storage is 60 MWh, making it approximately 10 times more than what is in use today on board a ferry. This makes it a first for such a large installation. A system level schematic of the battery system and its configuration is as shown in Figure 4. The battery storage consists of Corvus Blue Whale modules and operates at a system voltage of 1100 volts. These modules are mounted in sub structures also designed by Corvus.

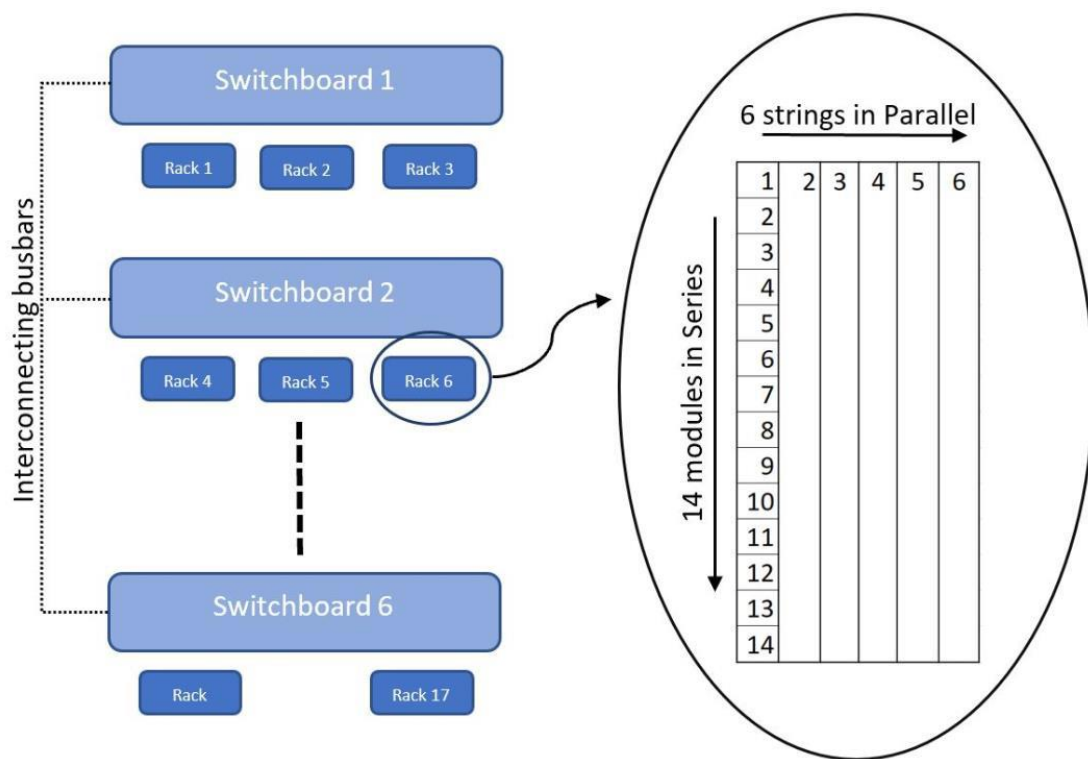

Figure 4 Schematic of the battery system configuration from Electric Light [4]

There are different interpretations of what is a battery module. The testing standard from International Electrotechnical Commission (IEC) 62619 Secondary cells and batteries containing alkaline or other non-acid electrolytes - Safety requirements for secondary lithium cells and batteries, for use in industrial applications defines a module as a “group of cells connected together either in a series and/ or parallel configuration with or without protective devices (e.g., fuse or positive temperature coefficient device (PTC)) and monitoring circuitry”. This is a vague definition and the project group also used wordings as:

- Smallest piece to move around and interconnect.
- Smallest airtight component – that has an off-gas duct.

4 Past battery accidents

Three relevant battery room accidents have been reviewed in this project. Two of them are from maritime applications and one from land-based application.

4.1 MF Ytterøyningen, 2019

The fire on board the passenger ferry Ytterøyningen was a fire with subsequent gas explosion [6]. Because no official fire investigation report has been found in open source, the following information is put together from information sheets, news articles and evaluation reports from the Fire and Rescue Service taking part in the firefighting intervention.

The fire broke out during the evening of 10 October 2019. From the safety message released by Norwegian Maritime Authority, all shipowners with vessels that have battery installations shall carry out a *"new risk assessment of the dangers connected to possible accumulations of explosive gases during unwanted incidents in the battery systems."* [7]

Ytterøyningen was recently (during 2018/2019) rebuilt into an electric ferry with a separate space for battery and energy storage, total capacity of 352 lithium batteries with total capacity of 2 MW with a liquid coolant system [6]. The ferry is 50 m long and 14 m wide. The extinguishing system for battery packs and panels was a saltwater sprinkler system (manual release). The battery compartment was also equipped with a chemical agent fire protection system called Novec. When the fire was detected, the ferry was using diesel engines and not the battery power. [6]

The ferry used its own propulsion to shore and evacuated the passengers. The local Fire and Rescue Service was alarmed and participated in the intervention. The first observation by the Fire and Rescue Service was smoke and no visible flames. Since people were evacuated and the fire was reported to be located in the battery room, the firefighters adopted a cautious approach to the intervention. The focus was to not let the fire spread further in the ship. Temperature was measured to 50 °C on the hatch to the battery room, firefighters was going down into the ship to investigate if the fire was spreading to other parts, and what was the actual fire source. [5] The crew informed the Fire and Rescue Service that it was ongoing service in the battery room and that they think it is not a battery pack that is on fire, rather electrical cables. The crew said they tried going into the battery room but then focused on evacuation of the ship instead. Further they informed that the extinguishing system was released, but with unknown effect on the fire, so also the water-based sprinkler system, and the fire alarm was triggered. The battery alarm monitoring the battery packs was disconnected due to the service and therefore not triggered. [6]

The fire was reported under control after some hours, and the temperatures was measured to 35 °C on the hatch, almost no smoke was visible at this time. During the evening, however, the temperature and smoke increased again. Firefighters going into the ship again trying to extinguish, and smoke is now spreading due to the opening of doors. Temperature is regularly checked during the night and at 05.00 in the morning they open the hatch to ventilate the battery room. The temperature starts to raise again and before 06.00 there is an explosion in the battery room of the ferry due to

accumulated un-combusted flammable gases where mixed with oxygen when the hatch was opened.

The first recommendation that was sent out from Norwegian Maritime Authority and Corvus Energy four days after the accident was that the ship needs to be sure that the communication between the energy management system (EMS) and the battery packs is working, and the vessel shall not operate without this communication [7] [8].

In the preliminary findings, according to Corvus and published on Norwegian Maritime Authority website the 12 December 2019², the origin of the fire was most likely a leak from the cooling water system of the battery pack [9]. The leakage was mostly likely caused by a twisted gasket in the cooling system and the usage of seawater extinguishing system was preliminary judged to be part of the reason why the event escalated. In the same publication it is also stated that no part of the battery system was connected to the shipside systems at the time of the incident, due to the ongoing service work. Therefore, no alarms from the battery system were sent through the ships alarm system.

4.2 MF Brim Explorer, 2021

MF Brim is a hybrid catamaran passenger vessel designed to use electricity as the main power source, and diesel-fuelled propulsion as back-up power source. The vessel was newly built and handed over from the shipyard in October 2019. The fire broke out on the afternoon 11 March 2021. The fire alarm panel indicated fire in the starboard battery room and the starboard engine room. Prior to the fire alarm, an alarm was shown on the energy management system (EMS) on the bridge. This system receives information from the battery management system (BMS) and the skipper thought it was due to a ground fault in the BMS. To find out more, a crew member was sent to check the BMS panel (located in the port engine room) and further investigate the alarm but did not get there before the fire alarm went off. The BMS indicated an overheating of a module. While there were many alarms on the BMS panel., there was no alarm on the 230 V panel. [10]

The battery rooms were situated below deck, with access through the engine rooms. There was one battery room in each hull, in total two battery rooms, and two engine rooms. The battery system had a total capacity of 792 kWh. [10]

The crew opened the door to the starboard engine room and brown/yellow smoke was seen; no flames was visible. The smoke was also seen on the camera surveillance (CCTV) and the skipper could confirm the fire in the engine room. After this, the fire routines were initiated; ventilation was switched off, fire dampers on the starboard side were closed, watertight doors were closed, and the starboard main engine was emergency stopped. [10]

Norwegian Safety Investigation Authority investigated the fire and the key conclusions from the investigation were as follows [10]:

- Fire technical investigations has shown that the fire started in battery string 6 in module 1. Seawater most likely penetrated through the ventilation outlet in

² [Supporting preliminary findings after battery incident - Norwegian Maritime Authority \(sdir.no\)](https://sdir.no)

the tunnel (between the hulls of the catamaran) and flowed further through the ventilation fan and down on the batteries. This led to short circuits and arcs with consequent fire.

- The investigation has shown that the location of the ventilation outlet in the tunnel was unfavourable and without sufficient measures to prevent water penetration. Neither the yard, DNV nor the Norwegian Maritime Directorate identified that the ventilation fan in the battery compartment was a leak point with regard to seawater intrusion. The freeboard plan lacked important information about filling points from the ventilation system to the battery compartment. This meant that those who approved the freeboard plan in the Norwegian Maritime Directorate were not aware that the ventilation outlet was located in the tunnel.
- Furthermore, the investigation showed that the low degree of protection of the battery system contributed to the fact that saline liquid could penetrate battery modules and high-voltage parts. A higher degree of ingress protection (IP) would reduce the consequence of water intrusion.

The vessel was towed and was docked to a quay in the evening the same day. Fire and Rescue service entered the vessel and chemical divers were set onboard to measure temperature and detect gas. The door to the battery room measured approximately 30 °C. Carbon monoxide (CO) and explosive gases were detected, also the next day CO and hydrogen sulphide was detected. The risk for explosion was seen as high and a team from various organisations (police, health service, coastal administration, insurance company, battery contractor, shipping company and the defence research establishment) was gathered. [10]

Brim was not designed to facilitate the removal of gases with suction, purging of gases, but this solution was proposed by the gathered team and carried out. Hazardous gases were removed from the vessel using a suction pump and using nitrogen to replace the oxygen in the air and prevent the formation of an explosive gas mixture in the hull. Continuous measurements showed that explosive gases were being sucked out and that the explosiveness of the atmosphere was brought down. 16 March the vessel was considered safe for fire and rescue personnel to go onboard and measure gas levels in the engine room and in the battery room. Thereafter the rooms were open for natural ventilation. [10]

4.3 Fire at McMicken Battery Energy Storage System (Arizona), 2019

In April 2019 there was a voltage drop in the battery energy storage system (BESS) during a charge cycle. After this, there was a cascading thermal runaway scenario with off-gas creating a flammable atmosphere in the BESS and subsequently an explosion. The explosion led to injured firefighters and a total loss of the BESS. [11]

The technical report issued by DNV [11] after the accident list conclude five main contributing factors:

1. It was a single cell internal failure that cascaded.
2. The total flooding clean agent was not able to stop the thermal runaway.

3. It was a lack of thermal barriers between cells.
4. It was no ventilation means for off-gases.
5. It was a lack of procedure for emergency response in terms of extinguishing, ventilation, and entry.

Further, the report highlights that the standards available at the time of the accident had a focus to handle the fire, and not to reduce the risk for propagation from cell to cell or from module to module. The regulation Standard for the Installation of Stationary Energy Storage Systems provided by National Fire Protection Association (NFPA), NFPA 855, and the Underwriters' Laboratories (UL) 1973, UL 9540, and the UL 9540A test method are mentioned. It was concluded that present codes and standards are insufficient in addressing cascading events. [11]

Also, strategies for ventilation, extinguishing and cooling thermal runaway scenario are mentioned in the report, and the conclusion is that it is necessary with multiple barriers to prevent similar accidents from happening again. [11]

5 Project outcomes

In the following subsections, the outcomes of the work in this project are reported.

5.1 A view of present shortfalls in battery room ventilation

The first workshop resulted in discussions regarding the present shortfalls in battery room ventilations. This was discussed in terms of design, regulation, operation, and organisation. While the full table of notes from this discussion is found in *Appendix 1 – Workshop results*, the highlights are presented here below.

Regarding design, it was underlined by the HVAC representants the need for evacuation of off-gases and on what level of thermal runaway the ventilation shall be designed for. The battery manufacturers highlighted the importance of involving the battery supplier in the battery room design and in the holistic safety approach, since all battery systems have different concepts which shall be incorporated in the design. Ship owner representatives mentioning that different types of batteries may need different room design. Ship owner representatives also mentioned that it shall be clear what can be inside a battery room, both in terms of energy, and in terms of other equipment.

Regarding the regulatory aspects, it was agreed that regulations are lacking today, in many levels, and that further development is needed. Here it was also mentioned that different battery system might need different requirements, but that regulations shall not hinder the innovation and the fast evolution of batteries. HVAC representatives lifted that today there are no requirements on air quality, but rather on temperature and humidity.

In terms of operation, the main issue is to know when to ventilate the battery room, and increased guidance on emergency response on battery room fires. It was also highlighted that other hazardous scenarios than single cell internal faults should be considered.

Organisationally, it was emphasized the need for development of strategies for the crew on how to carry out ordinary work and how to handle anomalies in a battery room. It was considered important to know or have the possibility to understand what happens inside the battery room, for example with the help of sensors and video monitoring. It was expressed that this could be important for decision making in an emergency.

5.2 Result from workshops and focus discussions

Besides the abovementioned shortfall discussion, the first workshop included discussions and elaborations on solutions and hinders for a ventilation design concept. The main results from these parts of the work are taken into consideration when developing the ventilation concept, which is further reported in the following subsections.

A summary of the first workshop discussions is that normal operation needs further improvements in physical barriers to prevent hazardous scenarios seen in the previous accidents, for example to hinder water ingress and condensation in the ventilation ducts. Discussion on the redundancy of ventilation fans and the possibility to operate fans from both sides of the ship was also part of the discussion. In case of emergency, the discussion lifted the testing criteria several times. It was discussed at large if triggering a single cell to simulate failure was adequate for approval. Controlled tests can prove cell to cell propagation protection in modules but discounts scenarios where multiple cells have failed simultaneously.

While there are regulations in place to minimise mechanical damage by regulating the materials and placements of the batteries within the ship, two of the three accident examples previously described shows multiple cell failure with no external mechanical damage. A lot of the hazardous scenarios ended up in discussions including thermal runaway and it was also noted that not all battery chemistries can go into thermal runaway, and that the developed strategies and concept shall be kept general.

Regarding removal of damaged batteries, it was mentioned that it could be a challenge when located in the bottom of the ship as on the concept design used in this study. It was also discussed that enough space is needed between modules, both for maintenance as well as for safety and to enable removal.

The following subsections will go deeper into each specific topic of the ventilation design concept.

5.3 General concept

With numerous battery suppliers, battery design philosophies, cost brackets and ship owner choices, one fixed ventilation design or approach for all energy storage systems is not feasible. However, the dependence of the ventilation requirements on certain parameters can be defined and used for optimal design.

Two such crucial parameters are module design off-gas duct, and propagation safety level within module, as detailed below:

1. Module design – off-gas ducts: Some battery modules are designed as airtight containers with a vent that opens into an off-gas duct, while others are not

airtight containers and have no specific off-gas duct. If there is a thermal runaway event inside the module, the module with the off-gas ducts carries the off-gases, produced by the cell in thermal runaway, outside the battery room while the module without the off-gas ducts vents these off-gases into the battery room. This difference is crucial for designing the ventilation system of the battery room as the difference in having or not having an off-gas duct will certainly imply different ventilation rates within the room.

If a module does have an off-gas duct, a question is then raised about the sizing of this duct. What volume of gases should these ducts handle and how many cells in thermal runaway does this volume correspond to? As of today, modules with off-gas ducts are designed to handle volumes that correspond to a single cell in thermal runaway. If there is more than one cell that simultaneously goes into thermal runaway and releases off-gases, these ducts do not handle all the volume, and the gases are inevitably vented into the battery room. More about this is discussed in section 5.5.

2. Propagation safety level within module: While it is imperative to have a system as safe as possible with thermal runaway propagation protection between cells, it is not always possible to have this protection depending on the chemistry of the cell, manufacturing design etc. It is also not a requirement as of today to have propagation protection between cells within a module. While this does not affect ventilation directly, not having propagation protection between cells implies greater risk of propagation. Hence this also increases the need to have ventilation system that can ventilate the produced off-gases. Modules containing cells that do not have propagation protection between them do not also have off-gas ducts. This is because thermal runaway in one cell certainly propagates to more cells around it and the off-gas ducts are designed to ventilate gases from only one cell. For modules that do not have cells with propagation protection, there is a requirement that the propagation does not exceed 11kWh within the module [12]. Gases corresponding to this energy is too much in volume for off-gas ducts to handle.

The combination of these two crucial parameters can be represented as a matrix from which the best and the worst-case scenarios can be defined, see Figure 5.

		Cell-cell propagation protection	
		Present	Absent
Off gas ducts	Present	cell-cell propagation protection + off gas ducts	X
	Absent	cell-cell propagation protection + no off gas ducts	no cell-cell propagation protection + no off gas ducts

Figure 5 Matrix of off-gas versus cell propagation protection in a module

The best-case scenario, as we see it, is when a module has cell to cell propagation protection as well as specific off-gas ducts. In such modules, a thermal runaway condition in one cell will theoretically not propagate to the adjacent cells and nor will the off-gases be released into the battery room. This scenario can be further improved by designing the off-gas duct to handle gases from not one cell but rather from one “casualty unit”. This is discussed in further detail in section 5.4.

The worst-case situation is when a module neither has cell to cell propagation protection nor does it have off-gas ducts. In this case, as per DNV rules [12], propagation within the module is allowed up to a total of 11kWh. With no off-gas ducts, it is implied that the off-gases produced in these cells is directly released uncontrolled into the battery room. In this situation, a safety layer, which is the off-gas duct, is missing and hence increases the risk of reaching the lower explosion limit within the battery room.

5.4 Casualty unit

A casualty unit can be arbitrarily defined as a fixed number of cells, equal to the smallest number of parallel connected cells, within a module based on which the off-gas ducts can be dimensioned. The number of cells that form a casualty unit can thus vary between different modules. The need to define a casualty unit arises from the fact that all off-gas ducts as of today are designed to handle off-gases produced by a single cell in thermal runaway within a module. Industry standards also require tests to be made on single cells and the results are used to certify their use on board. While tests include overcharging, external short circuits, external heating etc, the trigger for thermal runaway used in all these methods is on a single cell. This might not be fully

representative of reality as in some of the accident cases as discussed in section 4 *Past battery accidents*, external short circuits caused by leaking coolant or due to saltwater ingress have resulted in the shorting of more than just one cell. Thermal runaway prompted in a single cell is representative of one test case, i.e., internal short circuit within a cell. This usually happens either due to a manufacturing defect or due to ageing in the cell that has resulted in dendrite growth.

5.5 Ventilation modes

In order to distinguish different scenarios and the different needs of the ventilation system, the ventilation operation can be designed and defined as different modes. These modes are based on different scenarios and the rates of ventilation in terms of the number of air changes per hour for each mode can be calculated on a case-to-case basis.

Basic ventilation: This mode of ventilation is the default mode of operation. Primarily the battery room air conditioning (AC) will run such that the battery room temperature is maintained at the recommended level and factors such as air quality and humidity levels are maintained as required. The inlets and the outlets for the room ventilation shall be kept open.

Preventive ventilation: This mode of operation shall be activated as soon as a thermal runaway is detected. The scale of the thermal runaway or its containment to a single cell or a single casualty unit should not affect the change of the mode of ventilation to preventive mode. In case the thermal runaway is limited to a cell, or a casualty unit and the module is airtight with dedicated off-gas ducts the room ventilation changing to preventive mode of operation shall be rendered irrelevant. However, this is still important as failure of cell-to-cell protection might lead off-gases to be released into the room despite modules having dedicated off-gas ducts. During this mode of operation both the inlet and the outlet of the battery room ventilation system shall be kept open, and fans shall run at a predetermined rate. This rate can be calculated based on the total number of cells in the battery, the free volume in the battery room and the rate of gas production and spread of thermal runaway for the specific kind of cells that have been installed.

Casualty ventilation: The casualty mode of operation is designed to operate the ventilation system at full capacity. This capacity shall be designed to evacuate production of off-gases assuming there is propagation within a complete module or beyond. The objective of operating the ventilation system in the casualty mode is to ensure that despite producing large volumes of off-gases, a concentration at or above the lower explosion limit is minimised within the room. Based on the free volume in the room, the rate of off-gas production and propagation in the modules, the rate of ventilation for this mode can be calculated as discussed in section 5.6.

Normal operation: Off-gases flow through the off-gas ducts. The inlet and the outlet of the room ventilation are kept open and is operating at basic mode of ventilation, see Figure 6. In this scenario there are no gases or fire on any scale in the batteries.

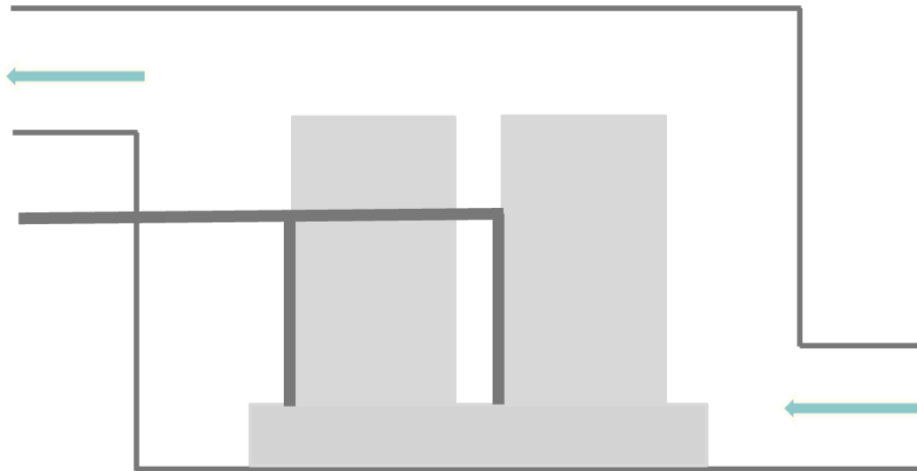

Figure 6 Normal operation in battery room. Room ventilation in basic mode.

Thermal runaway within a casualty unit: If there is thermal runaway in a single or a few cells within a module these gases shall be released out through the off-gas ducts. If the cell-to-cell thermal propagation protection works as intended, the thermal runaway condition is limited to this one or few cells and does not spread to the rest within the module. In this case, the off-gases through the ducts are all the gases that are produced because of the thermal runaway event. Although the off-gas ducts vent the off-gases from the cells, the room ventilation rate is increased as a precautionary measure and operates in the prevent mode. The rate of ventilation for this mode can be calculated on a case-to-case basis. The rate would depend on the free volume in the battery room, the capacity of the batteries, the capacity of the off-gas ducting, etc. The inlet and the outlet of the room ventilation are kept open to allow a higher rate of evacuation of gases from the battery room, see Figure 7.

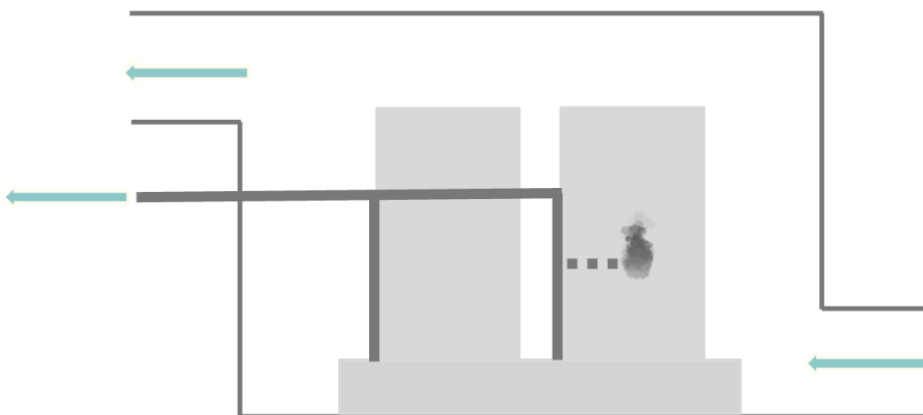

Figure 7 Thermal runaway in a cell or in a casualty unit and is handled by the off-gas duct. Room ventilation in preventive mode.

Risk: In case of a module which is airtight and has an off-gas duct, the primary risk is production of more off-gases in volume than what the off-gas duct can handle. This happens when the thermal runaway propagates to more cells than what the off-gas ducts can handle and thereby creates a risk of pressure build up within the module which might lead to an explosion. In case of modules that are not airtight and do not have an off-gas duct, the off-gases are released directly into the battery room which might increase the risk of reaching the lower explosion limit within the room.

Thermal runaway within a module: If the cell-to-cell propagation protection within a module fails and thermal runaway in a single cell or a single casualty unit spread to other casualty units or cells, the off-gas generated are more than what the off-gas ducts can handle. In this case the excess pressure within the module leads to the gases being discharged into the battery room. By now, the room ventilation is already operating in the preventive mode and when off-gases are detected in the room via gas sensors or when there is information from the BMS about the spread of thermal runaway to more than one casualty unit within the module, the ventilation in the room is amped up to casualty mode, see Figure 8.

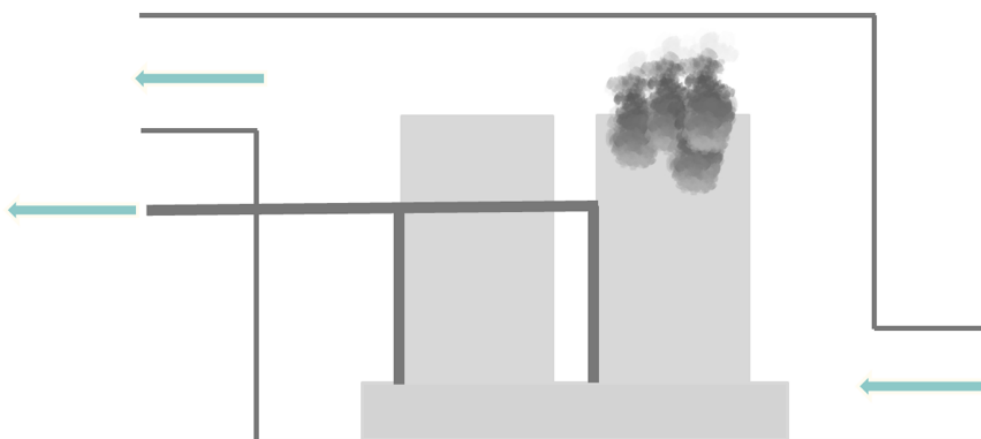

Figure 8 Thermal runaway in an entire module or multiple modules. Room ventilation in casualty mode.

Casualty ventilation is designed to cope up with gases produced by entire modules. If the thermal runaway has not resulted in a fire, the inlet and the outlet of the room ventilation can be kept open while the casualty ventilation mode is on. This maximises the possibility that the rate of evacuation of gases from the battery room is more than the rate of off-gas production.

Risks: With the spread of thermal runaway between cells or casualty units rapidly increases the risk of reaching the lower explosion limit within the battery room. A loss of communication between the BMS, relevant sensors and decision makers might result in the wrong mode of ventilation.

Fire scenario: In case of fires, having the inlet and the outlet open will force oxygen into the room which can cause the fire to spread. The strategy then can be to close both the inlet and the outlet of the room ventilation and let the off-gas ventilation be

kept going, see Figure 9, while a suitable fire extinguishing agent is discharged within the room. With under or over pressure being a concern, automatic flaps in the inlet and outlet closing devices can be utilised to normalise the pressure.

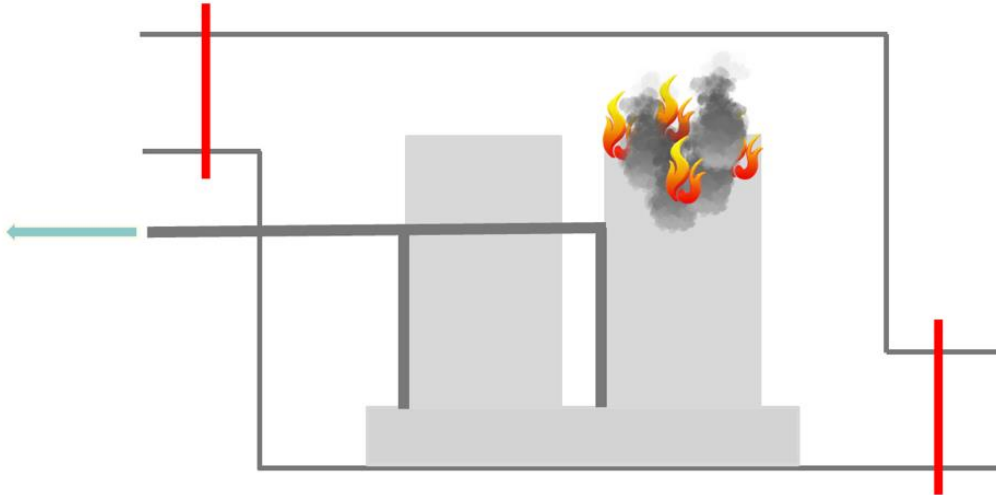

Figure 9 Inlet and outlet shut off during a fire situation to prevent fresh air and facilitate firefighting agents.

If the battery system configuration is tested with other ventilation concept in the room, in combination with a fire extinguishing system and sensors, and can show a safe approach, this can also be a possible concept.

Risk: A problem is that the batteries keep producing heat and off-gases as long as the thermal runaway continue. In case of the last concept, if the feedback from the room fails in showing decreasing temperatures or any sign of fire development or any failure in the feedback communication, the safest strategy is thought to be to close the ventilation, even if that means that flammable gases will be kept in the room. A clear strategy of how to release these gases after the event is crucial.

5.6 Ventilation calculation

The ventilation rates within the battery room can be quantified using air changes per hour (ACPH) as a unit of measurement. The ACPH defines the number of times the total volume of air is to be replaced within the said space. For one ACPH, the rate in volume (m^3) of air to be removed every minute, corresponds to the free volume of air in the room divided by 60.

$$\text{Rate of 1 ACPH} = \frac{(V_{Total} - V_{Batt})}{60} m^3 / \text{min}$$

For instance, for a free volume of $380 m^3$, for one ACPH, $6.33 m^3$ of air should be evacuated/replaced every minute.

Considering a thermal runaway condition in a single cell within a module without off-gas ducts, $0.2 m^3$ of gases are released over one minute into the battery room. If this is to be extrapolated to an entire casualty unit undergoing thermal runaway, $1.6 m^3$ of gases are produced over a minute and released into the battery room. With

approximately 23 such casualty units making up one module, and assuming the failure of cell-to-cell propagation protection measures, the total gas that is released by the entire module under thermal runaway will be about 36 m³. However, this 36 m³ of off-gases will not be released over one minute as it takes time for thermal runaway to propagate between so many cells. Based on these values, the actual ventilation rates for the battery room and the capacity of each off-gas duct can be calculated.

The off-gas ducts must be able to handle evacuation of 1.6 m³/min of off-gases from within the module. This corresponds to gases simultaneously released by all cells within one casualty unit.

Basic ventilation: The basic ventilation can be a low value as the battery room air condition (AC) system regulates the temperature for optimal operation of the batteries. In this mode of operation, the number of ACPH is relevant only for human working conditions within the battery room. This is generally not of consequence as regular human activity is not expected in the battery room.

Preventive ventilation: This mode of ventilation is started as soon as a thermal runaway event is detected irrespective of it being in a single cell or in a casualty unit. For a system with off-gas ducts for every module, the preventive ventilation rate can be more conservative than for a system without off-gas ducts. For the example case assuming thermal runaway in the casualty unit, 1.6 m³ of gases are produced over one minute. With the presence of off-gas ducts, ideally there should be no use of the preventive ventilation system as all gases are evacuated from within the module through the off-gas ducts. However, for a similar system without off-gas ducts, the same volume is released into the battery room and the preventer ventilation system should be designed to evacuate these gases as they are being produced.

The casualty ventilation system is to be designed very conservatively as the purpose is to handle uncontrolled thermal runaway conditions within the battery rooms. The objective here is to evacuate all the off-gases as they are being produced, to prevent pressure build-up within the battery room, to prevent the room gas concentration reaching the lower explosion limit and to reduce risk of ignition. For the example of *Electric Light*, if all cells within one module are in thermal runaway at the same time, 36 m³ of gases are released over one minute. This corresponds to six ACPH in the battery room, evacuating 38 m³ of gases every minute. Although this theoretically means that the volume of produced gases can be evacuated, the off-gases will be mixed with air and can therefore form an explosive environment. The gas production rate, propagation rate and probability of self-ignition of the gases is dependent on battery chemistry, which was described in section 3.1 and such knowledge need to be considered when designing casualty ventilation. The lower explosion limit values are also dependent on the battery chemistry [13].

12 air changes per hour corresponds to approximately 75 m³ of air evacuated every minute and is almost equal to twice the volume of gases produced by a full module. The actual number of air changes per hour for the casualty mode, like in all other modes is dependent on the free volume in the battery room. The conservative nature of the

design can hence be based on the number of modules it has to handle for a given battery room.

5.7 Design of battery room ventilation

The five battery rooms are located between deck 1 (1.5 m above the base line (ABL)) and deck 2 (5.5 m ABL), which is also the lowest cargo deck. They are symmetric around the centre line between traditional B/5 longitudinal bulkheads and constitute parts of the watertight integrity of the ship, see General Arrangement in *Appendix 2 – General arrangement Electric Light*. Each battery room contains four battery racks with a capacity of 3.61 MWh each, except for the smaller forward room with only one rack, see Figure 10.

The battery rooms will each be fitted with a ventilation inlet close to the deck on one side and an outlet close to the deck beams of the above cargo deck on the other side. The ducting of the in- and outlet will terminate through the hull just below deck 6, 17.5 m ABL or 11.5 m above the water line, Figure 11 and Figure 12.

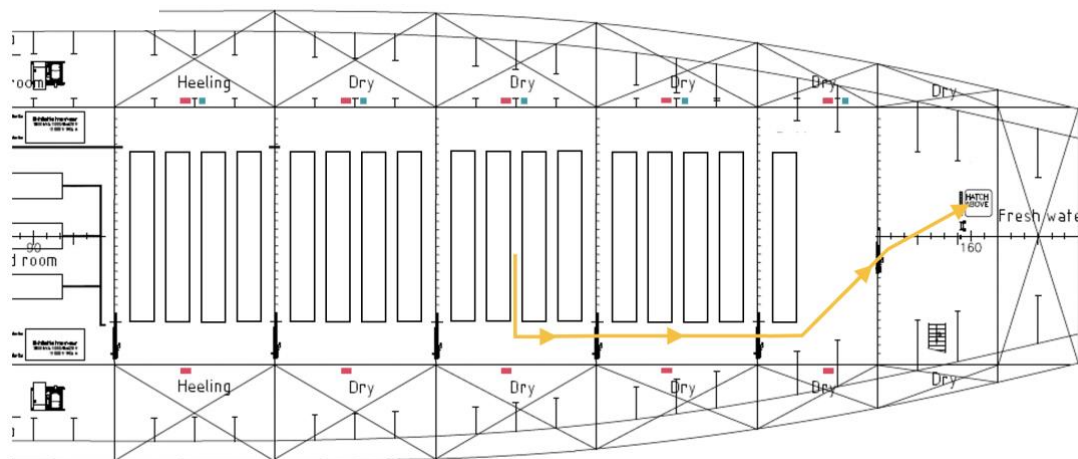

Figure 10 Layout of the five battery rooms on Deck 1. Yellow arrows depict an example transport route of a battery unit in the middle battery room. Main ventilation ducts are shown in red and off-gas ducts in blue.

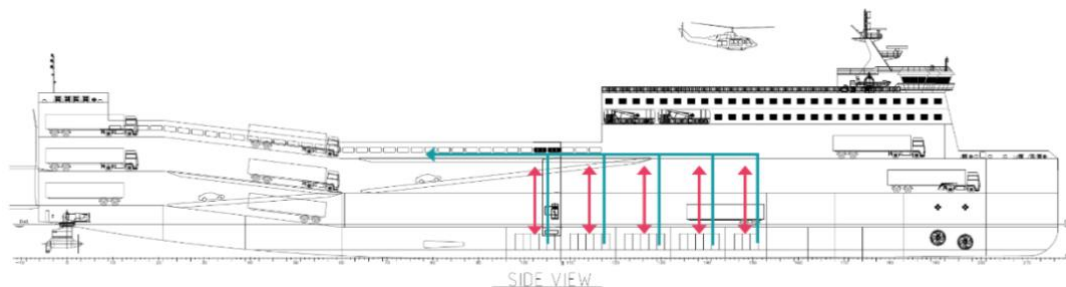

Figure 11 Ventilation (red) and off-gas ducts (blue) of the battery rooms.

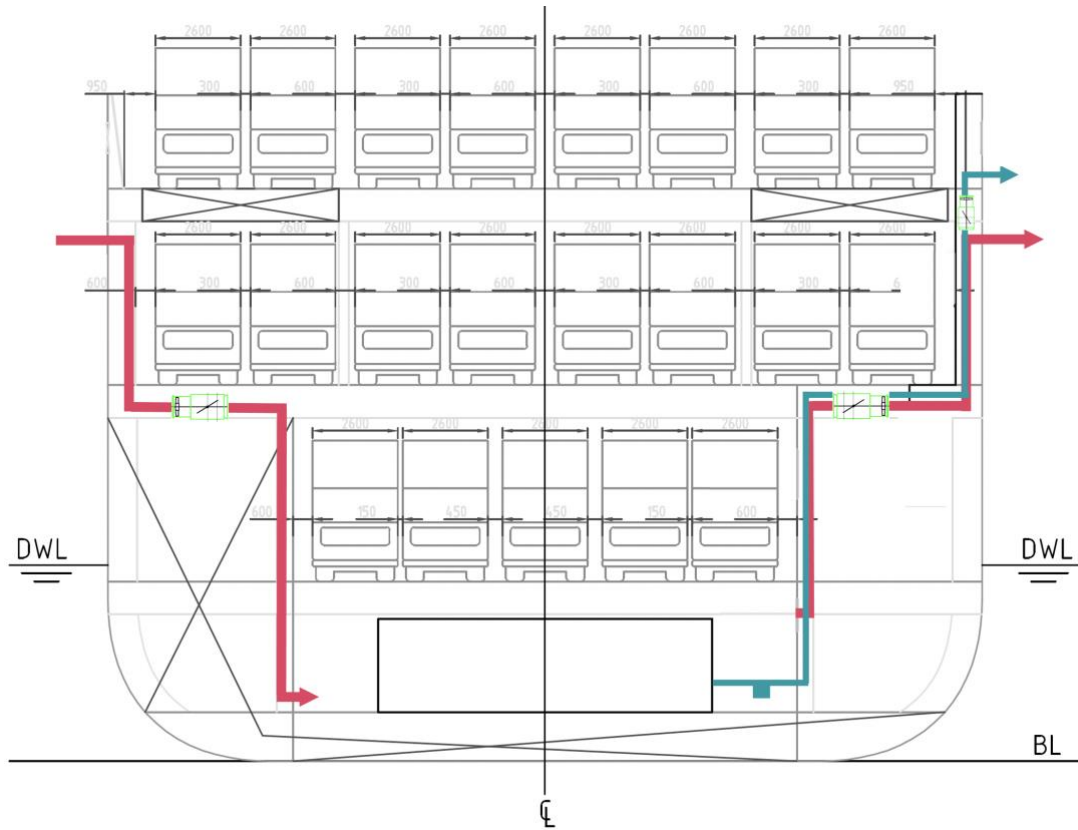

Figure 12 Routing of the ventilation (red) and off-gas (blue) ducts. A low spot container on the off-gas duct is outlined to the right of the battery pack.

The volume of air, V_{air} , within a battery room, i.e., the difference between room gross volume and the volume of battery racks plus miscellaneous appliances, is about 380 m³. With this and a required number of air changes per hour, ACPH, and mean ventilation duct flow velocity, v_{duct} , the cross-sectional area of the ducts, A_{duct} , can be calculated through:

$$A_{duct} = ACPH \cdot V_{air} / v_{duct} \cdot 3600$$

Assuming 6 ACPH as regulated for example in Bureau Veritas Rules regarding safety and design issues for battery compartment [14] and a 3 m/s flow velocity³, the cross-sectional area will be 0.211 m². This area can be achieved with a rectangular duct with dimensions 0.35*0.60 m which will fit on top of the longitudinal girders and in-between frames of the longitudinal bulkheads, deck beams and web frames, see Figure 10. Both inlet and outlet ducts will be fitted with one ventilation fan each for redundancy, which was suggested during the first workshop, and for post-fire strategies see section 5.8. The fans will be safe for use in hazardous area, EX-rated.

The batteries will also be fitted with dedicated off-gas ducts to transport off-gases to the outside environment during a thermal runaway scenario. These will be separate

³ These figures may not be the final design values but rather serves the purpose to obtain reasonable dimensions of the ducts. 6 ACPH is the current minimum capacity for battery rooms, e.g., [14]. 3 m/s is a low ventilation velocity and could be increased to meet casualty ventilation requirements of higher ACPH described in 5.5.

from the room ventilation ducts but have a similar routing with the exception that they will also be routed aft ward at deck 6 to keep the outlet away from people in the deck house area.

Off-gas ducts will be connected to the smallest air-tight units of the batteries, the battery modules. The ducts from each module will be connected to one larger duct for each battery rack. Ducts from each rack within a room will in turn be connected such that there will be only one off-gas duct leading out from each battery room. At each module connection there will be a “pressure release disc” that will also serve as a non-return valve to stop off-gases from other modules to enter that module.

A schematic drawing of the ventilation of the battery rooms is shown in Figure 13. Here also some of the innovations resulting from the workshops and focus discussions are shown. During the first project workshop a concern was raised that the off-gas ducting can be obstructed by e.g., condensation water or sea water spray entering the outlet of the duct and that this could cause rupture of the ducting in case of a thermal runaway event. To mitigate this a pressure release valve can be fitted on the off-gas duct, close to the battery rack, that would release the off-gases in a more controlled manner into the battery room where they can be ventilated out of the ship through the room ventilation. A prevention measure could be to fit a low spot container on the off-gas duct that would collect potential water in the duct and that can be emptied when water is detected or on a regular basis, see also Figure 12. Another measure could be to fit, for example, a mushroom type of ventilator at the outlet to prevent water spray to enter the duct.

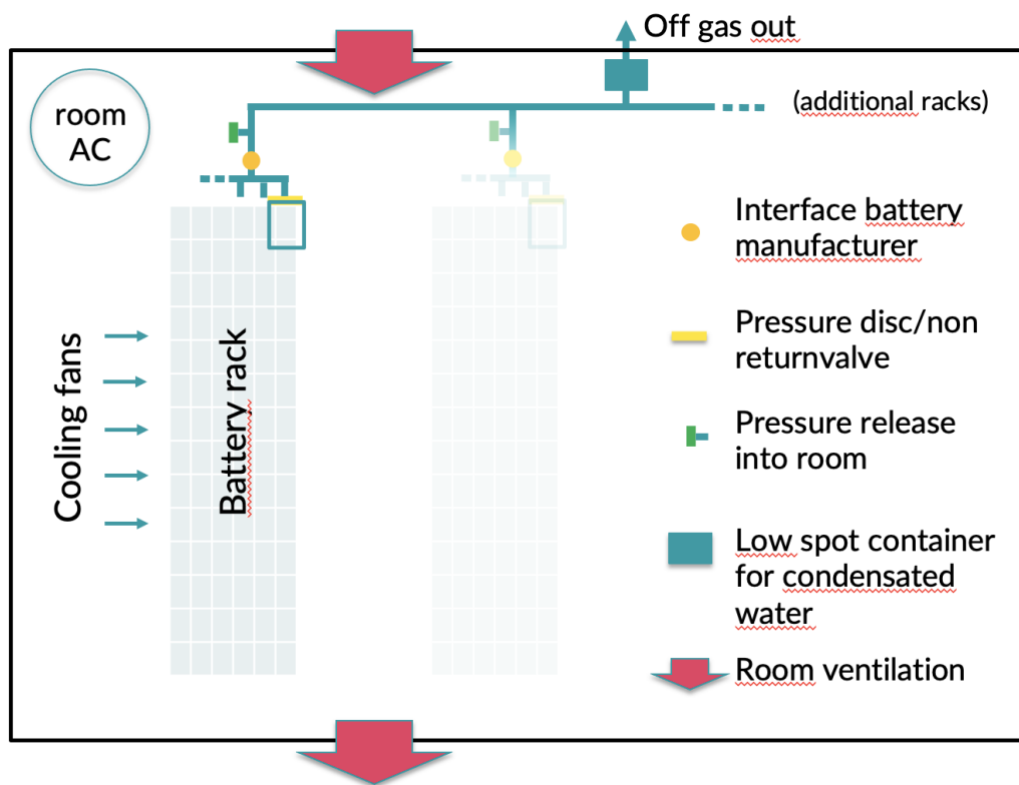

Figure 13 Schematic drawing of ventilation in battery room.

The size of the off-gas duct will be determined by the number of cells in a casualty unit, see section 5.4. A cell in thermal runaway will release 0.2 m³/min and with eight cells in a casualty unit and a flow velocity of 3 m/s the cross-sectional area of the duct will be $8 \cdot 0.2 / 3 \cdot 60 = 0.009$ m². This correspond to e.g., a pipe with 0.11 m diameter, which can be routed in the same manner as the main ventilation ducts, see above. The off-gas ducts within the battery racks will however need to be smaller to fit and thus be capable of higher flow velocities. The off-gas ducts from each battery room will be fitted with an EX rated extraction fan.

In the event of a battery module failure, or regular maintenance, it is of importance to have procedures and competence to handle and/or replace the units. This is also especially important as all module failures do not necessarily mean a thermal runaway condition. For instance, a faulty cable, an external mechanical failure, or a blown module fuse need to be dealt with but not the same as if there was a thermal runaway in the module. In the current design, with wide battery racks on the centre line, the watertight doors between the battery rooms will be placed on one side as to allow for unobstructed passage of the faulty unit to the compartment in front of the battery rooms, see Figure 10. Here the unit can be hoisted through a hatch to the HVAC room on Deck 2 and be further transported to the ro-ro decks above through a lift.

In [12] DNV have a limit for maximum installed energy in a battery room of 5MWh. With this limit the present design would need twelve battery rooms instead of five. To obtain this the current battery rooms could be subdivided with two transverse bulkheads per room, see Figure 14. This would however be highly impractical due to high cost and worse availability around the battery racks. Also, as the current design is more or less optimized for both damage stability requirements and hull strength it would not benefit from the additional watertight bulkheads. The 5MWh limit is possibly due to lack of design experience with fully battery powered ships of present size. In section 5.9 it is argued that this limit may not be needed in terms of fire safety.

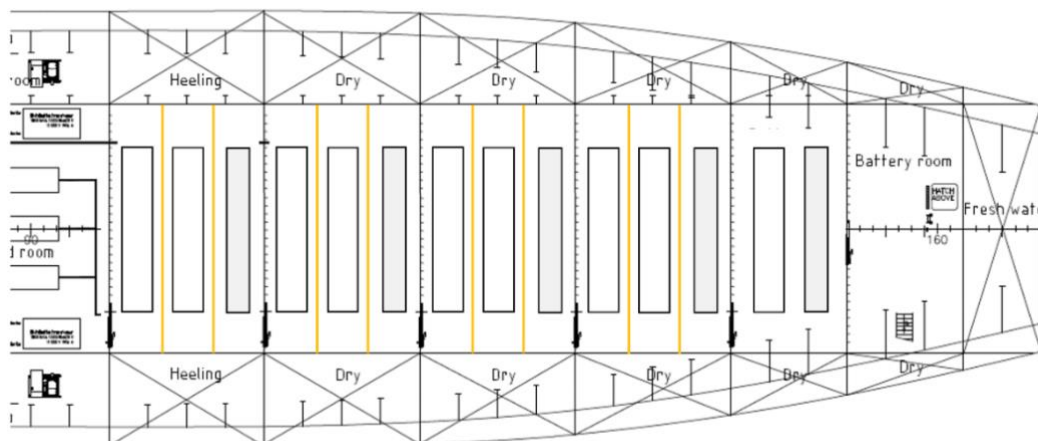

Figure 14 Possible layout of battery rooms with 5MWh/ room limitation. Yellow lines correspond to bulkheads subdividing the typical original battery room into three. A combination of battery racks with eight strings, 4,81 MWh/ rack and six strings (original design, in grey) are used, to better utilize available space and to preserve the total amount of energy capacity.

Safety systems in the battery room such as gas detection and video monitoring were highlighted in the discussion on the first workshop. A gas detection system is needed both in the off-gas ventilation duct and in the room. Video monitoring should monitor the modules and help understand what happens inside the room. Detectors monitoring the lower explosive limit (LEL) will also make it easier to understand what is occurring in the room, and in the main ventilation ducts, in terms of explosive atmosphere. The type of gas and LEL detection will need to be recommended based on the off-gas list which should be available and shared from the battery supplier. Today it is common with a carbon monoxide detector (CO) to detect the toxic part and a methane (CH₄) or hydrogen (H₂) gas detector to detect flammable gases. CO is argued to be good for early detection of a thermal runaway event, although there are a lot of initiatives today investigating detection for thermal runaway. Therefore, it may be justified to have both a CO and a LEL detector in the off-gas ventilation and in the room. It is important that the LEL detector can handle the mixture of combustible gases.

5.8 Post fire/emergency strategies

A post-fire strategy has been discussed in this project. Not only fire incidents shall be included in a strategy after an emergency, but also other incidents, for instance if the modules shall be replaced for other reasons, will need strategies for safe operation. After discussions in this project, it was agreed that a damaged module is safest if staying in its place but being electrically disconnected. A safe storage room was discussed but not deemed safer since the same issues will arise to move a damaged battery somewhere, and that transportation itself can initiate hazardous scenarios. A damaged battery should be handled by trained personnel when the vessel is safe in port. Good procedures must be in place for this though, for all involved personnel, also for the trained personnel. Procedures for removal of batteries are also needed in case modules are not damaged but need to be exchanged for other reasons. Discussions on who concludes if a module is damaged and needs exchanging, as well as if it should be a requirement to store spare modules onboard, were also discussed.

After an accident, the question is when it is safe to enter the battery room. So, if the module is electrically disconnected and awaiting removal, what shall happen? Even if the possible fire is extinguished, electrical energy can still be left in the battery system. This may be called stranded energy, which can be seen as electrical energy that cannot safely be discharged through the system interface after an incident that has damaged the battery cells. This can for example be mechanical, electrical, or thermal abuse, and does not include cable faults that has not damaged the battery cells. Any post-fire procedure may include:

- How to safely disconnect the damaged unit.
- How to lift and move modules safely (minimize risk of drop or other mechanical damage).
- Route to use when transporting the damaged unit.
- What personal protective equipment (PPE) to use and who shall wear it.
- Where to put the damaged unit.

- What to do if anything is happening during the transport (temperature increase, smoke release, short/arcing).
- How stranded energy can be removed and where, for example with manual conductive discharge, saltwater submersion, or combustion).

Note that the procedures would probably look different depending on degree of damage. The supplier of the modules and BMS could together with the operator, through risk assessment, define the procedures for handling the abovementioned situations.

A battery room can at this point have an explosive environment if the ventilation concept does not have the capacity to remove all the off-gases that are produced. The battery room can be opened by purging the room first. Purging can be explained as flushing with an inert gas to decrease the concentration of the flammable gas mixture in the room, so that an ignition cannot occur. For this project, purging with nitrogen (N_2) was introduced because of the successful intervention in the Brim accident, see section 4.2. In the Brim accident it was decided to remove flammable gases from the battery room using suction and using nitrogen to displace the oxygen in the air which then prevent the formation of an explosive gas mixture in the hull. Brim was not designed to facilitate a purging of the battery room, so a practical solution had to be found. In the designed battery room in this project, nitrogen can be released into the inlet valve, and then the outlet valve is also opened in casualty ventilation mode, so that the battery room is filled with nitrogen. The explosive atmosphere is vented out, eventually nitrogen can be replaced by air.

5.9 Relevance of battery chemistry and battery size

Both LFP and Ni-based Li-ion cells (the chemistries are described in section 3.1) are frequent in literature regarding batteries. LFP cells, in comparison with Ni-based cells, have in general a higher thermal runaway onset temperature, slower temperature increase rate, lower maximum temperature, as well as a lower total amount of gas production [5]. For ventilation considerations, the gas production is important. The total gas production during a thermal runaway is highly dependent on the state of charge (SOC). At 100% SOC a good estimate of the total gas production for Ni-based cell types is 2 L/Ah, while it may be only the half amount for LFP cells [15]. However, the specific total gas production (L/Ah) can sometimes be higher for LFP-type cells, which depend on the SOC and the amount of electrolyte in the cell [15].

The gas production will affect the peak heat release rate (pHRR) and total heat release (THR), additionally these parameters are also influenced by the failure scenario (test methodology). Since LFP-type cells generally have a lower energy density, compared to Ni-based cells, the normalised THR can be higher [16].

The slower temperature increase rate and lower maximum temperature for LFP-type cells results in a lower probability of thermal runaway propagation and a lower pHRR on system level [17]. The THR is primarily correlated to the total chemical energy available, which may vary between different types of cells e.g., power optimised cells versus energy optimised cells. Additionally, due to the lower maximum temperature,

LFP-type cells are typically less prone to self-ignite in contrast to cells that contain a high nickel content. For cells with a high nickel content, a vast number of ejected hot particles are commonly noticed upon thermal runaway, which can ignite the released gases far away from the cell itself. Whether flammable gas release without early self-ignition is a lower or higher risk will depend on the application and the fire scenario. A non-ignited flammable gas cloud may result in more severe consequences compared to a flaming fire, as the risk for gas explosion increases.

Studies on LTO cells are less frequent in literature. The thermal stability is very good in a moderate temperature range due to the use of LTO instead of graphite, which facilitate e.g., use at high power. The solid electrolyte interface (SEI) layer on graphite anodes is typically the first to decompose at elevated temperatures. When temperature is further increased (in testing) the behaviour of LTO cells is similar to the behaviour of LFP cells, meaning similar temperature increase rate, maximum temperature and total amount of gas production during thermal runaway [18]. The thermal runaway onset temperature can be lower than for LFP cells [18], which correlates with RISE battery testing experience.

Despite differences in chemistry there is, based on test data, a correlation between installed battery capacity and total heat release during a fire [19]. There is also a correlation to pHRR, even though the data is more scattered since this is highly affected by thermal runaway propagation rate, which in turn is dependent on battery system design. Based on battery cell testing the pHRR may reach 1-3 kW/Wh [16], but based on large scale testing, taking into account realistic propagation rates (not all battery cells are burning at the same time), the correlation could be approximated by $1.6 \times E^{0.67}$ kW/Wh, where E is the installed electrical energy [19].

So, considering a battery room with 380 m³ free air volume, 6 ACPH would result in the following pHRR considering unlimited amount of fuel:

$$6 \times 380 \times 0.21 (O_2 \text{ conc.}) \times 1.43 (O_2 \text{ dens.}) \times 13.1 \left(\frac{MJ}{kg} \text{ consumed } O_2 \right) \\ = 8970 \frac{MJ}{h} = 2.5 MW$$

Now, using the formula for expected pHRR from a free burning battery fire, 2.5 MW correlates to 60 kWh installed electrical energy. For sure, this is associated with large uncertainties, but the conclusion would still be that an escalating fire event in a battery installation of MWh-range would very soon be ventilation controlled rather than fuel controlled. In terms of chemical fuel and possible burning time, 5 MWh installed battery capacity correlates to about 7000 L of diesel oil [19]. Thermal runaway in battery cells may propagate also without external fire but is likely to happen only when they are in close proximity, i.e., inside modules and not between modules and racks. In the theoretical case where a complete installation goes into thermal runaway without an external fire the energy release in terms of heat is just a tenth of the heat released in a battery fire.

With this background, it can be questioned, in terms of fire load, if an upper limit of the allowed battery capacity in a single battery room makes sense, if this is in the MWh range. A recommendation would rather be that the upper limit of energy in a battery room should be defined based on redundancy and the SOLAS regulation of casualty threshold and safe return to port (SOLAS II-2/21), e.g., limit the maximum capacity in a single battery room to a certain percentage of the total installed battery capacity of the ship and that the effectiveness of extinguishing systems in large battery rooms would then need to be validated for such fire scenarios.

6 Conclusions

This chapter includes the main conclusions from the project work.

The work in this project has been carried out by RISE and Chalmers together with industry participation in terms of workshops and focus discussions. The industry partners also had the opportunity to review the report before submission.

Conclusions from this innovation project are as follows:

- With numerous battery suppliers, battery design philosophies, cost brackets and operators' choices, one fixed ventilation design or approach for all energy storage systems is not feasible.
- Size of battery room, in terms of energy (5 MWh limit) is questioned. Both in terms of safety and in terms of design. It is rather recommended that the upper limit should be defined based on redundancy and safe return to port regulation.
- Regulations are limited as of today and are only a part of the classification societies rules and notations. This project more quantifies ventilation design and operation to further enhance existing and future regulations.
- Different modes of ventilation are defined and quantified for different scenarios. This is important as a slightly conservative approach for different conditions could prevent catastrophes by offering a layer of protection at different levels.
- Purging of off-gases has not been assessed as thorough as intended in this project and further assessments are recommended, and for this topic also include emergency response organisations.

7 References

- [1] International Maritime Organization, "Initial IMO GHG Strategy," [Online]. Available:
<https://www.imo.org/en/MediaCentre/HotTopics/Pages/Reducing-greenhouse-gas-emissions-from-ships.aspx>. [Använd 19 April 2023].
- [2] International Maritime Organization, "Revised GHG reduction strategy for global shipping adopted," [Online]. Available:
<https://www.imo.org/en/MediaCentre/PressBriefings/pages/Revised-GHG-reduction-strategy-for-global-shipping-adopted-.aspx>. [Använd 6 September 2023].
- [3] M. Hägg, S. Pettersson, R. Rylander, J. Östling, M. Borgh, M. Broman, V. Daun, J. Ellis, O. Lundbäck, V. Santén och M. Wikander, "Elektrifiering av sjöfarten – en nulägesbeskrivning av teknik och marknadsläge inom maritim elektrifiering och analys av behov och möjligheter för elektrifiering inom sjöfarten," Lighthouse, Göteborg, 2018.
- [4] O. Willstrand, V. Ramachandra, F. Evegren, M. Hägg, B. Ramne, Z. Li, F. Thies, J. Ringsberg och E. J. Lluís, "Lätta Elfartyg - Electric Light - lightweight and electrically propelled Ro-Pax ships," Lighthouse, Göteborg, 2021.
- [5] Y.-S. Duh, Y. Sun, X. Lin, J. Zheng, M. Wang, Y. Wang, X. Wang, X. Jiang, Z. Zheng, S. Zheng och G. Yu, "Characterization on thermal runaway of commercial 18650 lithium-ion batteries used in electric vehicles: A review.," *Journal of Energy Storage*, vol. 41, nr 102888, 2021.
- [6] Kvinnherad brann og redning, "Evalueringsrapport - Brann i MF «Ytterøyningen» 10.10.2019," Vest brann- og redningsregion, Bergen, 2019.
- [7] Norwegian Maritime Authority, "Battery fire with subsequent gas explosion," Norwegian Maritime Authority, Haugesund, 2019.
- [8] Corbus Energy, "Important Communique regarding Ytterøyningen Battery Fire," Corvus Energy, 2019.
- [9] Norwegian Maritime Authority, "Supporting preliminary findings after battery incident," 12 December 2019. [Online]. Available: Important Communique regarding Ytterøyningen. [Använd 4 July 2023].
- [10] Norwegian Safety Investigation Authority, "Fire on board 'MS Brim' in the outer Oslofjord on 11 March 2021," Norwegian Safety Investigation Authority, Lillestrom, 2022.

- [11] DNV-GL Energy, "McMicken Battery Energy Storage System Event Technical Analysis and Recommendations," DNV-GL, Arizona, 2020.
- [12] DNV, *Rules for classification, Part 6, Ch 2*, DNV, 2023.
- [13] W. Li, S. Rao, Y. Xiao, Z. Gao, Y. Chen, H. Wang och M. Ouyang, "Fire boundaries of lithium-ion cell eruption gases," *iScience*, p. 102401, 21 May 2021.
- [14] Bureau Veritas, *Rules for the classification of steel ships NR467, part F, Ch14*, Bureau Veritas, 2023.
- [15] O. Willstrand, M. Pushp, P. Andersson och D. Brandell, "Impact of different Li-ion cell test conditions on thermal runaway characteristics and gas release measurements," *Journal of Energy Science*, vol. 68, nr 107785, 2023.
- [16] T. Rappsilber, N. Yusfi, S. Krüger, S.-K. Hahn, T.-P. Fellingner, J. Krug von Nidda och Tschirschwitz, "Meta-analysis of heat release and smoke gas emission during thermal runaway of lithium-ion batteries," *Journal of Energy Science*, vol. 60, nr 106579, 2023.
- [17] B. Ditch och D. Zeng, "Development of Sprinkler Protection Guidance for Lithium Ion Based Energy Storage Systems," FM Global, 2019.
- [18] L. Yuan, T. Dubaniewicz, I. Zlochower, R. Thomas och N. Rayyan, "Experimental study on thermal runaway and vented gases of lithium-ion cells," *Process Safety and Environmental Protection*, vol. 144, pp. 186-192, 2020.
- [19] O. Willstrand, R. Bisschop, P. Blomqvist, A. Temple och J. Anderson, "Toxic Gases from Electric Vehicle Fires," RISE Research Institutes of Sweden, RISE Report 2020:90, Borås, 2020.

8 Appendices

1. Workshop results
2. General Arrangement of Electric Light

Appendix 1 – Workshop results

Notes from discussions from first workshop.

Table 2. Notes from the discussion regarding present shortfalls in battery room ventilation.

	Design	Regulation	Operation	Organisation
Ship operators	It depends on what types of batteries we are talking about. Different battery room design for different types of batteries. It shall be clear what can be inside the battery space. It should be limited equipment. Size of room and energy in one room would be regulated. Also, an issue on what level do we need to design for TR etc.	Further developing is needed in all levels. For the project, we should have detection included. Requirement of how many MW you can install in each compartment. DNV is in this discussion, so work is going on internationally. Possible guidance for gas detection in the battery space and duct?	Want to know when to ventilate? How to prevent an explosion since an explosion can lead to ship loss. A fire can also start somewhere else in the space, so we need to include scenarios on external fires, not only look at TR.	Detection (sensors/monitoring) of gases is important for the decision making. To understand what happens inside the room. Guidelines for the crew, how to act in case of fire battery room/pack.
Battery stakeholders	Holistic approach of the safety of the battery room is lacking. Extinguishing system, battery systems etc. are linked into the total safety of the room. Ventilation in combination with water mist for example, it is all connected. Maintenance of batteries shall be thought of in the design. Each battery supplier has different products and shall	Focus on preventing earth falls. Regulations shall not hold back/decrease innovation in battery development. Choice of chemistry etc. is part of the innovation and shall not be restricted. Question from project: Is there a need for battery manufacturers to share more information/specific details/tests on the cell level? Answer: The gas composition is required to be shared to the class for individual projects. Off gases are readily available.	ABB do not have so much in this are, they are in the ship integration phase and deliver the battery. The shipyard designs the ventilation requirements. Training for battery fires. Norwegian Maritime Authority have developed a	

	<p>also be encouraged to be included in the holistic safety of the battery space. Battery suppliers need to take a bigger responsibility for the design of the battery space. Perhaps the equipment supplier shall be “approving” the battery space before taking into use. All systems have different concepts/design and need special considerations.</p>	<p>Cell manufacturers will not be happy to share even more. Characteristics on the TR behaviour on the module can be shared more. Propagation rate for example.</p>	<p>guidance for the ship operators, what to know/train when operating battery ferry.</p>	
<p>Ventilation stakeholders (Agree also with above comments)</p>	<p>The big concern is if TR gases are leaking into the battery room. It shall be possible to evacuate TR gases in the design.</p>	<p>Battery can be located in different compartments...rooms/containers, what types of space are this, leading into interpretation, can be clarified. Different battery chemistry might need different rules. Rules shall not limit the fast evolution of batteries. Safety first! Regulations are lacking today. Today nothing is specified on air quality. Today temperature and humidity are parameters, no more.</p>	<p>Detection – CCTV shall be part of this, it gives a good understanding. Cruise ships have safety management systems with different strategies for different spaces.</p>	<p>It shall be developed certain strategies for the battery space. Not only for ventilation, also for disconnection etc. Crews are coming and going. Good experience from cruise ships.</p>

Table 3. Notes from discussion regarding normal operation scenario.

Scenario	Design of ventilation, piping/sizes, fans, capacity etc	Management of ventilation (how to change, active/shut off)	Comments, pros/cons etc.
<p>Normal operation</p>	<p>Reversible fans increase manageability of the ventilation system.</p> <p>Water intrusion alarm in the ventilation duct. Water lock. Off gas duct can now have saltwater ingress from sea water. It can be too late to have the detector in this pipe. Load line convention dictates regulation for height of intake.</p> <p>Will the fans need to be EX? Interlock? Exhaust fans are EX classified.</p> <p>Ventilation of room and ventilaton of battery pack shall both be considered.</p> <p>Fresh air for supply and spark proof fan for exhaust.</p>	<p>Air change as required, (based on heat dissipation from battery manufacturer.) Provide battery rack to keep the levels. In case of fire, tradition – ventilation is shut off.</p> <p>Possibility to ventilate on both ship sides. Engine rooms have reversible fans and strategies for management. Different if persons entering or not, and for cooling. Strategies for minimizing the risk for accidents. Visual indication needed before entering the room?</p>	<p>BESS guidelines ongoing. NFPA not require ventilation in normal operation for li-ion, as for other battery chemistry.</p>
<p>Aspects of battery space location</p>	<p>WD location, the off-gas duct is away from the accommodation or other areas. Fans are running continuously, not integrated in BMS.</p>	<p>Indication if fans are running. Alarms if not running fans is important.</p>	

Table 4. Notes from discussion regarding saltwater ingress scenario.

Scenario	Design of ventilation, piping/sizes, fans, capacity etc	Comments, pros/cons etc.
<p>Saltwater ingress</p>	<p>Gooseneck. Off gas ducting – description of allowable back pressure (combination of diameter and pressure), which shall ensure no water ingress. Burst disc. There are class rules to follow. IEC also have rules on product level. Condensation can create a small water flow.</p> <p>Blockage of pipe can be an issue.</p> <p>Separate the off-gas ducting from the battery space vent. DNV have regulations on this, keep separate.</p> <p>What happens if the design value is exceeded? Have this been investigated? Pressure will increase and most likely leak gas into gasket.</p> <p>Bad combo with water coming in at same time as release of gases.</p> <p>Design criteria that water shall not be able to come into the duct. Condensation water can such a risk.</p> <p>Create redundancy in ventilation, this can prevent blockage. And together the redundant can handle more than one cell.</p> <p>Pressure relief valve on the off-gas duct inside of the battery room? Good idea, wonder what class will say. Better to release into the room than other space.</p> <p>The cabinets will crack, are not made for withstanding pressure, or higher release of gases.</p>	<p>Not necessary on the cell level that mitigate water ingress.</p> <p>One cell can propagate.</p> <p>Many suppliers succeed in stopping cell level propagation. But mechanical damage can cause rapid propagation in the whole system. Ola wants test on both cell level and module level.</p> <p>Class to be included in project. Norway (DNV) was in front of battery. All class are active. Ok to ask DNV for this project.</p>

Aspects of battery size	How many modules can be linked together in the piping for off gases? Now, it is the single cell that sets the design value.	Corvus so far not experience the single cell fault. Leaking pipes are more common.
Aspects of battery space location	11 kWh module level propagation if modules are designed without TR safety system (today's class requirement). It can be bigger if other systems. Blockage of duct, not necessary more gas to be handled.	Find out if blockage of duct can be a scenario, then it shall be tested for.
Battery chemistry? Switchboard?		Different battery design can react different on salt water.

Table 5. Notes from discussion regarding thermal runaway scenario.

Scenario	Design of ventilation, piping/sizes, fans, capacity etc	Management of ventilation (how to change, active/shut off)	Purging of flammable/hazardous gases, emergency	Technical strategies after accident	Comments, pros/cons etc.
Thermal runaway	Off gas duct not always present on other battery designs. Some off gases are vented into the room. Explosion analysis, the base is the propagation test and determine how many cells going into TR.	Combination of extinguishing system and ventilation system, when to active or shut off, this can be further discussed.	If possible, to keep fans on this might be best solutions to remove gases.	Look at Brim accident: Novec was released. Not enter the room. Land based firefighters introduced Inert nitrogen into the room. Normal ventilation, fans from	Different design. Modules is stacked, first remove all modules on top. It is time consuming. Module fuse – remove the module and replace the fuse. All modules not placed inside the racking

	<p>Other fires, not caused by battery. Class rules state that other equipment shall not be inside the room.</p> <p>Scenarios that the batteries are not designed for can be drop of module during installation, external fire, left in corner before installation/service.</p>	<p>Also, as mentioned for the cruise ships, to have strategies for different scenarios and spaces.</p>		<p>fire department connected with ship ducts.</p> <p>Firefighters wanted to go in since no high temperature, but it may not be safe even if temperatures are low.</p> <p>Can nitrogen be a solution also on sea voyage? Depends on the design of battery spaces extinguishing system.</p> <p>Challenge to change batteries when in the bottom of the ship. It differs from battery supplier, how often you shall change the batteries.</p>	<p>need to be disconnected for off gas duct. Trouble with modules disconnected if on fire or TR. Also, scenarios before installed etc. drop the module can lead to ground fault/arc/etc.</p> <p>Separate the room and the system ventilation.</p>
<p>Aspects of battery size</p>	<p>Size is irrelevant for the size of what Electric light are looking at. Can be a difference for smaller application.</p>				<p>Some chemistries do not have TR.</p>

	The room size, Safe return to port is relevant.				Gas content of TR shall be basis for strategies. Keep it general.
Aspects of battery space location	<p>Look into location of ducts in the whole ship design.</p> <p>Batteries in the bottom is good since it uses the same space as the fuel did use.</p> <p>Batteries on WD can lead to stability issues in the Electric Light design.</p>				<p>Also use common sense. Double bottom can be too conservative. Can be optimized more.</p> <p>LNG tank was mentioned.</p>

Appendix 2 – General arrangement Electric Light

The general arrangement from Electric Light [4].

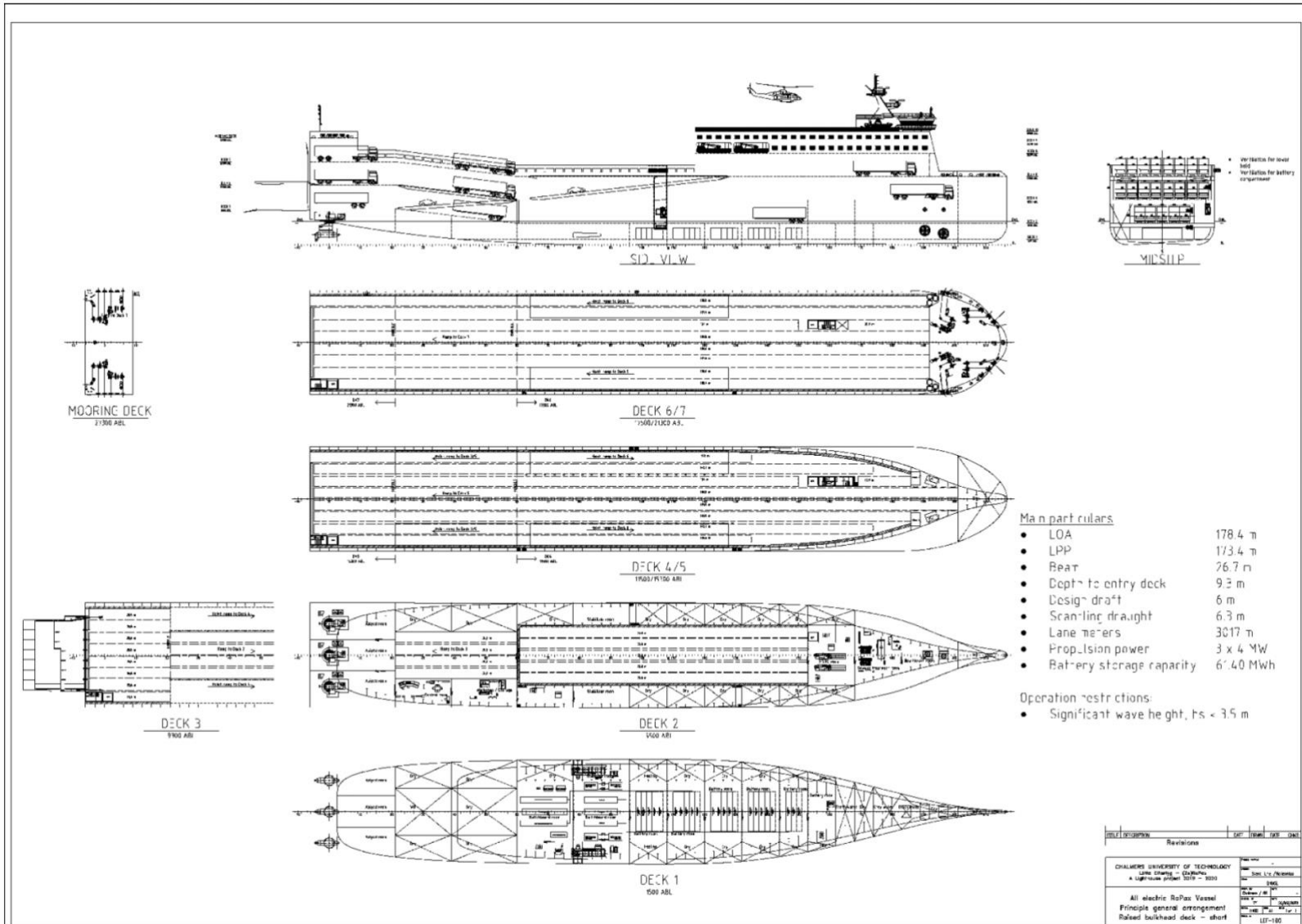



Lighthouse gathers leading maritime stakeholders through a Triple-Helix collaboration comprising industry, society, academies and institutes to promote research, development and innovation within the maritime sector with the following vision:

Lighthouse – for a competitive, sustainable and safe maritime sector with a good working environment

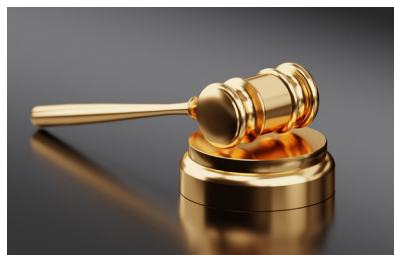

LIGHTHOUSE PARTNERS



LIGHTHOUSE ASSOCIATE MEMBERS

