



Designing Multi-Technological Resilient Objects in Product Platforms

Downloaded from: <https://research.chalmers.se>, 2024-12-02 18:19 UTC

Citation for the original published paper (version of record):

Alonso Fernandez, I., Panarotto, M., Isaksson, O. (2022). Designing Multi-Technological Resilient Objects in Product Platforms. Proceedings of NordDesign 2022: How Product and Manufacturing Design Enable Sustainable Companies and Societies. <http://dx.doi.org/10.35199/norddesign2022.40>

N.B. When citing this work, cite the original published paper.

Designing Multi-Technological Resilient Objects in Product Platforms

Iñigo Alonso Fernández¹, Massimo Panarotto², Ola Isaksson³

¹*Chalmers University of Technology, Sweden
Inigo.Alonso@chalmers.se*

²*Chalmers University of Technology, Sweden
Massimo.Panarotto@chalmers.se*

³*Chalmers University of Technology, Sweden
Ola.Isaksson@chalmers.se*

Abstract

Uncertainty about the market, environment, and technological landscape of the future challenges the ways companies utilize the notion of “product platforms” to gain efficiency during development and production. This paper reviews design approaches to cope with uncertainties and highlights the benefit of designing a platform to enable “resilience” to deal with uncertain situation without the need to change the structure or configuration of the product platform. To achieve resilience, the paper proposes to introduce “resilient objects” in regions of the product platform that are likely to be most affected by change. Resilient design objects are already common in practice, such as a spring-damper system in mechanical systems. However, since product platform are multi-technological, this paper proposes a way of representing generic resilient objects (along five different design domains) for multi-technological systems. This proposal is supported by illustrative examples. Future research opportunities are identified around extending the matrix of generic multi-technological resilient objects, and defining a systematic method to design, select and evaluate which resilient objects are more valuable to be inserted in specific regions of the product platform.

Keywords: *product platform, multi-/cross-/trans-disciplinary approaches, design objects, characteristics and properties*

1 Introduction

Today all sectors of the economy are affected by many uncertainties, and a good example is the automotive sector. Customers are posing increased demands on product functionality, performance, and environmental efficiency, and regulatory requirements are expected to continue to raise the bar on energy consumption and safety in the next years (Bielaczyc & Woodburn, 2019). At the same time, new ground-breaking technologies (e.g., digitalization (Llopis-Albert et al., 2021), electrification (Lequesne, 2015) and automation (Siroki et al.,

2019)) are maturing and are expected to be integrated into products to meet such increased demands from customers and society. These changes in market, regulations and technology introduce uncertainties that are challenging the ways in which automotive products are designed and managed today.

In the automotive industry, manufacturers have for a long time invested in product platforms to gain cost efficiency and quality (Simpson, 2004). Product platforms are a collection of modules or parts that are common to several products (or variants). In this way, products can be made unique just by swapping some distinct modules. Using a platform approach, highly customized products can be offered in a resource-efficient way (Meyer and Lehnerd, 1997). Since many years, the industrial practice has adopted several design principles to define a product platform, for example by using standardized interfaces between pre-defined modules (Ulrich, 1995; Otto et al., 2016), so that certain product modules can be changed if new conditions arise (Sethi and Sethi, 1990). While applying these principles has many benefits, this way of dealing with platforms is challenged nowadays. The increased uncertainty that automotive manufacturers face today causes the escalation of the risk of unforeseen changes, resulting in new modules that must be developed and replaced, no matter how easy the change of the module can be made. This has negative implications for both the cost efficiency of the manufacturer, as well as for the sustainability of society.

The objective of this paper is to find ways to support - through design - situations in which the designer wants to protect against uncertainty with minimal impact on the overall platform structure. Therefore, this study is focused on the following research question:

RQ: How can an uncertainty-protected product platform be designed at an early stage, with minimal impact on the overall platform structure?

To answer this research question, the paper first reviews different approaches to cope with uncertainty in product platforms. The analysis will point to the benefit of designing a product platform to enable **resilience** against uncertainty. Afterwards, this paper will present practical means to apply this resilient approach, by introducing a series of ‘resilient objects’ that can absorb change with minimal impact on the overall platform. Resilient design objects are commonly found already in practice (e.g., common spring/damping solutions in mechanical systems). However, since platforms are multi-domain (i.e., they mix hardware, electronics, software, and service components), an adaptable solution for a platform needs to provide mechanisms to provide adaptive and resilient elements of different nature. So far, no way of representing generic resilient objects and design solutions for multi-technological systems has been proposed.

2 Background: design approaches to protect against uncertainty

Conceiving a system that is protected against uncertainty is commonly understood in design (Thunnissen, 2005), and designers make interventions to protect against uncertainty, either explicitly or implicitly (Crawley et al., 2004). These interventions result with the design possessing systemic properties called ‘-ilities’ (e.g., **changeability**, **flexibility**, **adaptability**, **scalability**; Ross et al., 2008). Although there has been an increase of publications on ‘-ilities’ in the recent years, there is still a confusion regarding the proper use of these concepts (Chalupnik et al., 2013). This lack of clarity makes it difficult to systematically use these concepts during design. In the field of engineering design, Chalupnik et al. (2013) made a classification based on the point of view that ‘-ilities’ are providing different forms of system **reliability** (i.e., ‘minimizing unwanted variance in performance’; Hollnagel, E. 1993). This classification is shown in Table 1.

Table 1. A classification of conceptual approaches to system protection against uncertainty (adapted from Chalupnik et al., 2013). Note: S = System; E = Environment; R = Requirements.

Concept	Source(s) of uncertainty	Variable requirements	Variable environment	Variable structure	Active protection considered
Reliability	S				
Robustness	S+E		✓		
Adaptability	S+E		✓	✓	✓
Versatility	S+R	✓			
Resilience	S+R+E	✓	✓		
Flexibility	S+R+E	✓	✓	✓	✓

The classification is based first on the source of the uncertainty that the ‘-ility’ concept is protecting against: system, environment, or requirements. In traditional **reliability** literature, systems are considered reliable if they have predictable performances in stable environments and stable requirements (Chalupnik et al., 2013). However, systems often are subject to changes both in environment and in requirements. When the environment is subject to change while the requirements remain stable, **robustness** and **adaptability** concepts can be applied. **Robustness** and **adaptability** have similar definitions in literature (McManus & Hastings, 2005; Fricke & Schulz, 2005). However, the main difference is that **adaptability** applies an active protection against uncertainty (de Neufville et al., 2004):

- *Active protection* is when the system can adapt itself and its structure to deal with unknowns.
- *Passive protection* is when the system can deal with uncertain situation without the need to change its structure or configuration.

Therefore, the objective of **robustness** is to minimize the impact of uncertainty without changing the structure, whereas **adaptability** implies uncertainty minimization through restructuring.

When the system is also subject to changes in requirements, the concepts of **versatility**, **resilience** and **flexibility** can be applied. In **versatility**, changes in the environment are not considered (Chalupnik et al., 2013). **Resilience** and **flexibility** instead consider changes in environment (besides changes in system and requirements). Although there are not univocal and distinct definitions between **resilience** and **flexibility**, their difference is considered to be in their mode of coping with uncertainty (Chalupnik et al., 2013). While **resilience** has the focus to minimize the impact of uncertainty without changing the structure (passive protection; Chalupnik et al., 2013), **flexibility** implies uncertainty minimization through restructuring (active protection). **Resilience** implies the ability of a system to return to its original (or desired) state after being disturbed’ (Christopher & Rutherford, 2004) and the ability to ‘bounce back from adversity’ (Hollnagel & al., 2006). Some general design principles to achieve **resilience** are:

- By possessing reserves to accommodate unforeseen changes (Hollnagel & al., 2008).
- By absorbing and utilize change (Weick & al., 1999).
- By recovering from perturbation (Fiksel, 2007).
- By preventing adverse events (Hollnagel & al., 2006).

The next section will further analyse literature to highlight the benefit of adopting resilient design principles to protect against uncertainty in next generation product platforms.

2.1 Motivations for applying resilient design principles to next generation product platforms

As stated in the introduction, the uncertainties that are affecting the automotive sector today are likely to change both requirements and the external environment in the future. Therefore, both **resilience** and **flexibility** can be applied to design uncertainty-protected product platforms.

It can be observed that much of the industrial practice so far has focused on designing platforms that deal with uncertainty through restructuring (i.e., active protection against uncertainty; de Neufville et al., 2004; Qureshi et al., 2006). For example, leveraging the concepts of modularity (Otto et al., 2016) and increasing the ability to change modules in the platform (Suh et al., 2007) by using standardized interfaces (Ulrich, 1995). Looking at the classification of Table 1, it can be observed that these principles focus on enabling the **flexibility** of the platform, based on the principle of conceiving a system with relatively low capability initially, but that allows for expansion if changes occur (de Neufville et al., 2011). While applying these principles (based on active protection against uncertainty) have many benefits, they present some challenges for next generation platforms:

1. Platforms are rarely completely modular and flexible but are often a mix between modular and integral architectures (Höltkä-Otto & al., 2007). This implies a risk that a change will propagate through the system via the interactions with other modules (Clarkson et al., 2004). This will cause a premature and unforeseen need to change interconnected modules in the system.
2. Platforms are multi-domain, i.e., need to systematically organise a mix of hardware, electronics, software and potentially also services (Pelliccione et al., 2017). Since software and electronic elements are difficult to be intuitively separated into physical components – compared to mechanical elements – it is more challenging to identify interactions (Kreimeyer & Lindemann, 2011). This result in a higher difficulty to foresee change propagations effects among interacting elements in the software, electronic, and hardware architecture.

Therefore, using solely **flexibility** design principles (dealing with uncertainty through restructuring) could result in modules to be continuously added and changed to modify the system structure, no matter how easy the change of the module can be made. This has negative implications for both the cost efficiency of the manufacturer, as well as sustainability for society.

To resolve these challenges, this paper presents alternative ways of designing a product platform to enable **resilience** instead (i.e., based on passive protection that copes with uncertainty with minimal need to change the overall platform configuration).

3 Designing multi-technological resilient objects

To enable resilience in product platform, this paper proposes to use a series ‘resilient objects’ that can absorb change, and to place these objects in regions of the product architecture that are most affected by change. Also, these objects can be used to interrupt the chain of change propagation among interconnected components. The next section will introduce the active use of resilient objects with an illustrative example.

3.1 Illustrative example: jaw coupling as a resilient object

The example is related to a jaw coupling (Figure 1), which is a type of general-purpose power transmission element. It is designed to transmit torque (by connecting two shafts) while damping system vibrations and accommodating misalignment, which protects other components from damage. Jaw couplings are composed of three parts: two metallic hubs and an elastomer (e.g., “rubber”) inserted in between the hubs (also called a “spider”). The three-parts press fit together with a jaw from each hub fitted alternately with the lobes of the spider. Figure 1 shows a schematic comparison between 1) Platform A: a product platform designed to enable flexibility (based on active protection against uncertainty) and 2) Platform B: a product platform designed to enable resilience (based on passive protection against uncertainty). To achieve this passive protection, Platform B uses the jaw coupling as ‘resilient object’. For simplicity, Platform A consists of three modules (a motor, a shaft, and a gearbox). The motor is providing torque to the gearbox, transmitted by the shaft. In Platform B, the jaw coupling is inserted in the middle of two shafts instead. The objective of the figure is to highlight how the jaw coupling acts as “resilient object” to better accommodate three changes of requirements (scenario a, b, and c).

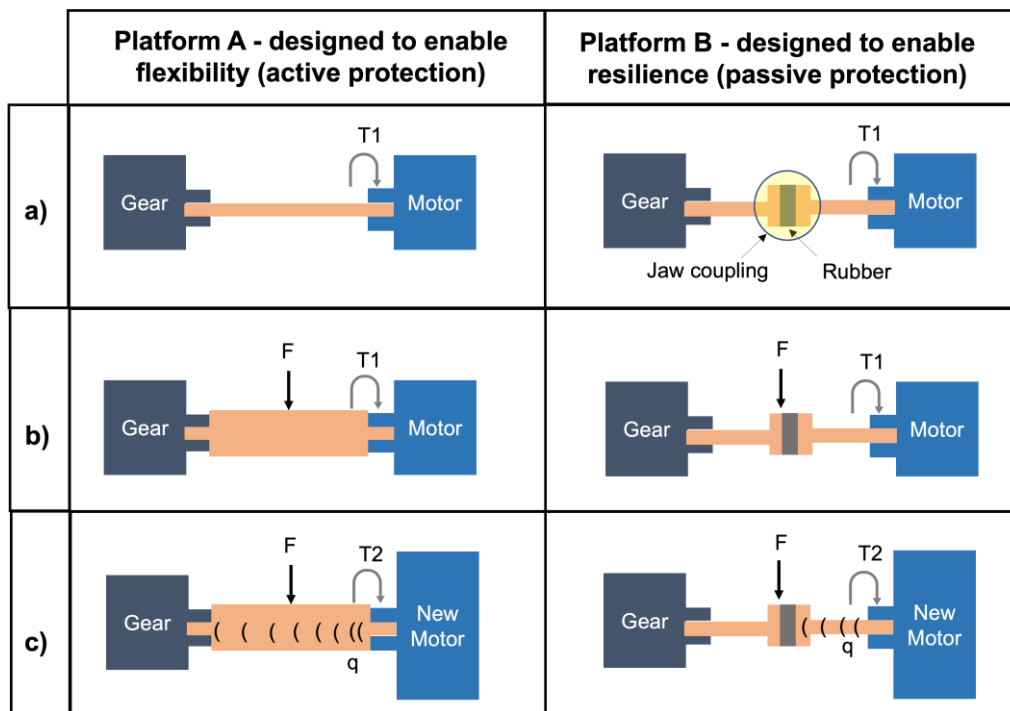

Figure 1. Comparison between a product platform designed to enable flexibility (active protection against uncertainty) and a product platform designed to enable resilience (passive protection against uncertainty) using a jaw coupling as ‘resilient object’.

In the first scenario (Figure 1-a), the customer requests to transmit a certain torque (T_1) from the motor to the gear. In Platform A, the designer applies flexibility design principles: the system is conceived with relatively low capability initially, but that allows for expansion if changes occur (de Neufville et al., 2011). Following this principle, a shaft that can transmit T_1 is conceived. At the same time, future changes in the requested torque are considered, by designing standardized interfaces (Ulrich, 1995) between the shaft, the motor, and the gear. In this approach, the system is very easy to be changed if higher requirements for the torque should arise.

However, a new unforeseen requirement may be demanded by the customer, which is not connected to the torque to be transmitted. In this case (Figure 1-b), the customer may request to

sustain a load (F) in the middle of the shaft. This new requirement brings a series of negative effects, namely vibrations and misalignments on the shaft that can damage both the motor and the gear. In Platform A, this change can be accommodated by restructuring (Chalupnik et al., 2013). For example, a shaft with a higher cross section can be designed to eliminate the misalignment and - since the interfaces are standardized - it can easily replace the old shaft. However, this means that the old shaft must be scrapped. In Platform B instead, the jaw coupling can absorb the misalignment without the need to change the overall structure. The benefit of the resilient approach is further visible if a new requirement for the torque should arise (Figure 1-c). In this case, it is considered that the old motor is not able to deliver the requested torque (T_2). Therefore, a more powerful motor needs to be installed (“new motor”). In Platform A, the standardized interface makes it easy to replace the motor and connect it to the shaft. However, the need to fulfil T_2 with a more powerful motor has created a new undesired effect, the production of high heat (q) that propagates through the shaft and reaches the gear (negatively impacting its structural integrity). This means that to counterbalance this undesired effect a new change must be made, for example a new shaft or a new type of gear. In the resilient platform instead, the jaw coupling absorbs the heat, and the system can protect against changes in requirement maintaining the same structure. This has benefit in terms of cost efficiency and sustainability.

This example has highlighted how a jaw coupling acts as a “resilient object”, being able to absorb change and to interrupt the chain of change propagation among interconnected components. It is interesting to note that - among manufacturers - jaw couplings are marketed as “flexible couplings”. However, according to the definitions provided in literature (e.g., Chalupnik et al., 2013), jaw couplings can be seen as resilient objects, since they allow the system to protect against uncertainty without the need of changing the structure.











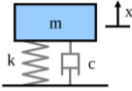
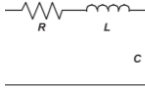

3.2 Multi-technological resilient objects: examples from literature

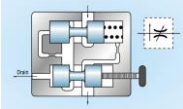
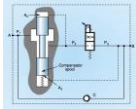
Table 2 presents a morphological matrix (Beitz et al., 1996) collecting examples of resilient objects. Resilient design objects are commonly found already (e.g., common spring/damping solutions in mechanical systems or condensers). However, no systematic way of representing generic resilient objects have been proposed, capable of representing resilient design solutions in multi-technological systems. Therefore, Table 2 represent resilient objects in four different domains – spatial/mechanical, hydraulic, electric and software - following the classification given by Pimmler & Eppinger (1994). During the analysis, it has been convenient to represent the objects merging the spatial/mechanical domain with the hydraulic, and the electronics with software. However, the objects often mix the four domains altogether. For example, an electrohydraulic proportional valve contains also mechanical elements (e.g., spools). We added the Service/Organizational domain to represent the artifacts used during the lifecycle of a system, with particular interest in the strategies and tools used in the design phases.

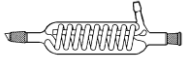
Table 2 also includes common/classical objects found in the literature, like the mass-spring-damper system can be used to study how to absorb oscillations in mechanical systems, but that has the power to model other systems with nonlinearities and viscoelastic behaviour, like, hydraulic systems, or discrete components electrical systems. Other classical examples include the absorption of pressure variations, or of thermodynamic loads. However, we are also including “resilient objects” to address types of changes that are not usually discussed in the literature as being possible to be absorbed by these alternative means. For example, to absorb misalignment, mechanically a simple rubber element might be used, and electronically controlled systems exist with sensors and actuators, but service measures like frequent inspection and preventive maintenance can also reduce the impact of the uncertainty associated with the onset of misalignments. Another example is the absorption of variations in input

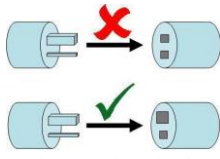
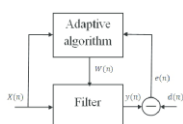
information, that can be minimized for instance mechanically by the introduction of fool proof elements (poka-yoke), electronically by adaptative algorithms, and organizationally using standardized forms and validation procedures.

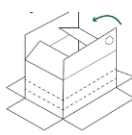
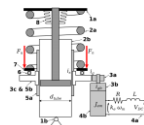
Table 2. Morphological matrix with examples of multi-technological resilient objects for different domains.

Function	Spatial / Mechanical / Hydraulic domain	Electric / Software domain	Service/ Organizational domain
Absorb oscillations	 <p>Spring – Damper</p>	 <p>RLC-based circuits (e.g., band-pass filter)</p>	 <p>Safety stock</p>
Absorb misalignment	 <p>Elastomers (e.g., rubber)</p>	 <p>Adaptive alignment devices</p>	 <p>Frequent inspection</p>
Absorb pressure variation	 <p>Pressure-compensated flow control valve</p>	 <p>Electrohydraulic proportional valve</p>	 <p>Early measurement /detection</p>
Absorb heat	 <p>Condenser</p>	 <p>Peltier plate</p>	N/A
Absorb variation in input information	 <p>Poka-Yoke design</p>	 <p>Adaptive algorithm</p>	 <p>Standardized forms</p>
Absorb demand for excess space	 <p>Multi-depth boxes</p>	 <p>Electromechanical adjustment mechanism</p>	 <p>Space Reservation Specifications</p>
Absorb supply chain disruption	N/A	Supplier Relationship Management (SRM) and AI Forecasting	Multi-sourcing Strategy

Expandable structures such as multi-depth boxes can be used to absorb the demand for future space, and to realize the desire to implement space reservations for future evolvability, a resilient object can be used in the mechanical domain such as a bracket, or adapter.

Supply chain disruptions can be mitigated by the used of Supplier Relationship Management (SRM) software coupled with Artificial Intelligence (AI) algorithms for modelling and forecasting demand, logistics, warehousing, etc. On the organization domain, this approach can be enhanced by different strategies, such as multi-sourcing, near-shoring, etc. More comprehensive and possibly valuable means of providing additional resilience can be developed by the combination of solutions from multiple domains into a common resilient object, as well as by also combining different functional changes absorption into a common object. The design process to come up and combine solutions can be enhanced by traditional ideation methods like brainstorming, TRIZ, biomimicry, etc.

3.3 Applying multi-technological resilient objects to product platform design

This section will describe how to apply the multi-technological resilient objects in product platform design and applied to the example of the jaw coupling already introduced in Figure 1. A generic four step process is applied.

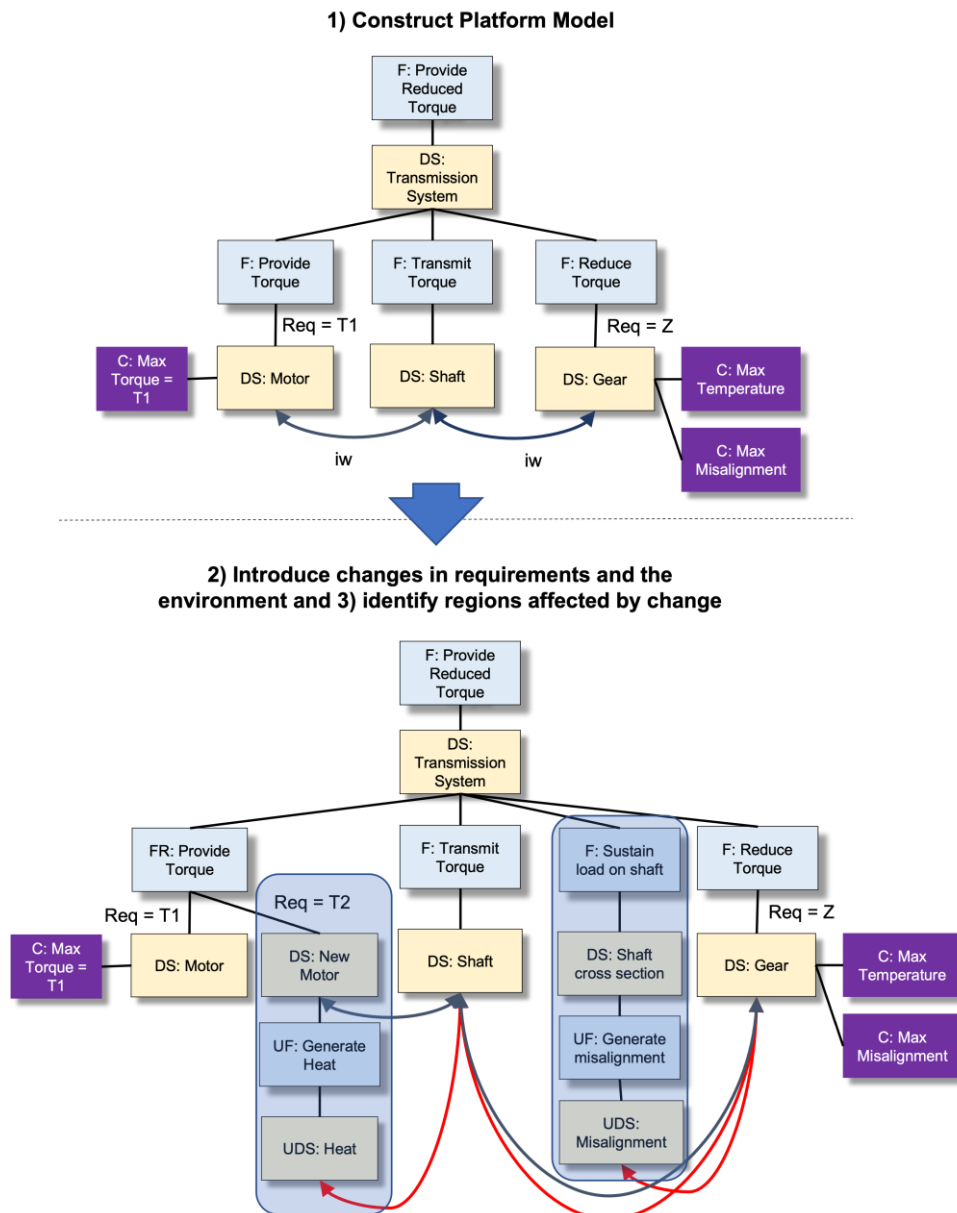

Figure 2. First three steps to apply the resilient design objects: 1) construct platform model 2) introduce changes in requirements and 3). identify regions affected by change.

1. *Construct product platform model (Figure 2).* The first step is to define a platform model. In this context, an Enhanced Function-Means (E F-M; Müller et al., 2019) tree modelling approach is used, due to its ability of representing functions, design solutions and interactions in the same model. Figure 2 represents the E F-M tree for the motor, shaft and gear, highlighting the functions (F) the design solutions (DS) and interactions among the elements (“interacts with”, “iw”, connections). The model also represents the constraints (C) for the different solutions, which represents the limit of the technology chosen. For example, the motor is constrained by the max torque that can be provided (T1). If higher torque is requested, the motor must be changed. This has profound implications if new requirements arise.
2. *Introduce changes in requirements and external environment in product platform model (Figure 2).* The next step of the approach is to anticipate changes in requirements (focusing on areas highlighted from existing technology roadmaps and market surveys), and their effects on the platform. In this case, two new functional requirements are introduced by the customer, a higher torque (T2) and the requirement to sustain a load in the middle of the shaft. The fulfilment of these two functions (by the new motor and the shaft cross section) will generate two “unwanted” effects: heat generation and misalignment. These are captured as unwanted functions in the platform model (“UF”).
3. *Identify regions of the product platform that are most affected by change (Figure 2).* The next step is to evaluate the impact that the changes in the requirement have made on the platform. For this purpose, Change Propagation Algorithms can be used (e.g., Clarkson et al., 2004). In this example, the negative impact is visualized qualitatively through “red iw” elements. For example, the heat generated from the new motor to the shaft propagates to the gear, which reaches the constraint related to the maximum temperature. In this case, a new gear with higher maximum temperature should be introduced. Another alternative is to “break” the chain of propagation by absorbing the change through a resilient design object.
4. *Make design improvements by introducing multi-technological resilient objects (Figure 3).* In this step, resilient objects are introduced in the platform. In Figure 3, the jaw coupling is introduced on the product platform, and connecting it to two separate shafts. The figure highlights how the jaw coupling breaks the indirect connection to the motor via the shaft. Now, this connection is through the jaw coupling. This connection enables to absorb both the heat and misalignment. The positive effect of this choice is shown by the “green iw” connections.

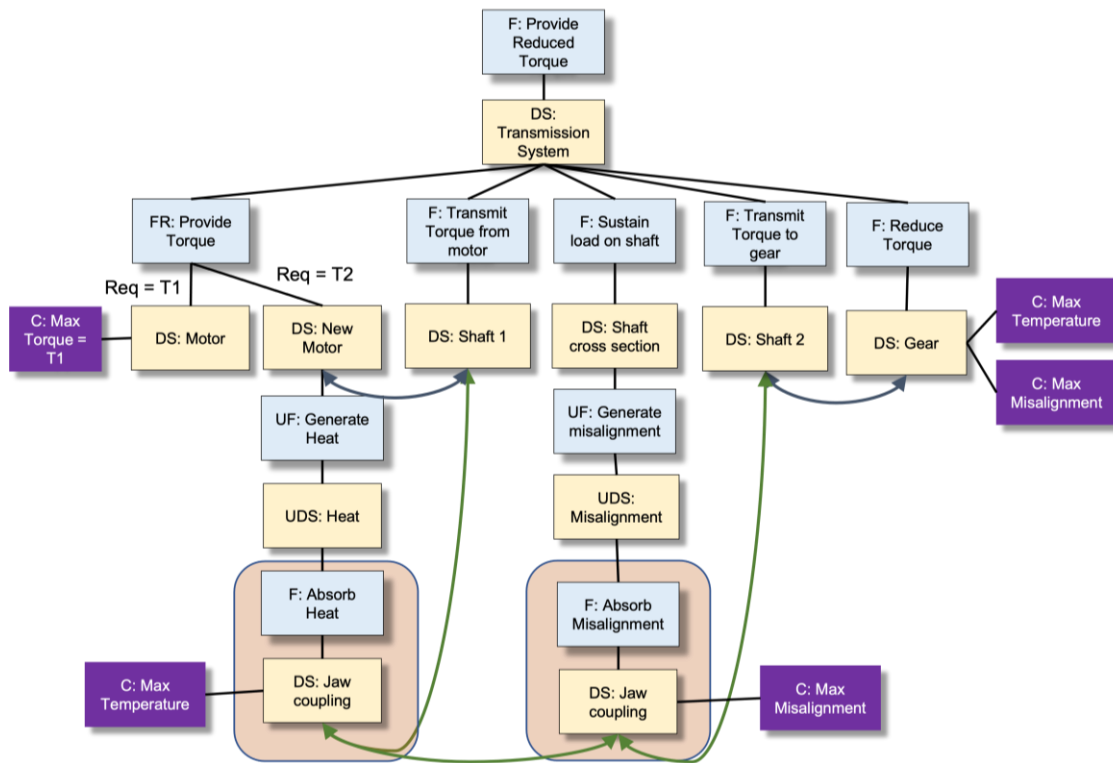

Figure 3. Introducing a resilient design object (jaw coupling) on the product platform, to “break” the chain of propagation by absorbing the change (visualized as “green iv” connections).

It is worth mentioning that also the resilient object has constraint, i.e., the limit of the technology to absorb change. These are captured as “constraint” objects. If higher changes are expected (higher misalignments or higher temperature), the jaw coupling needs to be substituted with a resilient object with higher potential (for example a condenser for liquid cooling or an electromechanical alignment device). A new “undesired” effect can be introduced, for example a defect in the sensor of the alignment device that causes a variation in the input given to the alignment device. This change can be absorbed by a new resilient object (Table 2), for example an adaptive algorithm that adjusts itself.

4 Discussion and conclusion

This paper has emphasized the benefit of designing a product platform incorporating “resilience” to deal with uncertain situations without the need to change the structure or configuration of the product platform. Instead of the “design for flexibility” approach of adapting the structure of the platform, the proposed approach emphasises the introduction of stand-alone components that embody the resilience and can absorb different types of changes. Incorporating resilience rather than flexibility has many benefits for both cost-efficiency and sustainability. However, the two strategies are not mutually exclusive. In the example of the jaw coupling (Figure 1), standardized interfaces are used to enable the change of the modules (e.g., the new motor).

This paper stressed that the need for restructuring should be minimized, by introducing generic “resilient design objects” (along five different design domains; Table 2) to absorb change in the regions of the product platform that are likely to be most affected by change. Also, these objects can be used to interrupt the chain of change propagation among interconnected components. Table 2 can be used as a “morphological matrix” to combine resilient objects in situations in

which many types of undesired effect could happen (for example, risk of oscillations, heat generation and need for excess space). The combination of the corresponding resilient objects in Table 2 could result in “super absorbers” to be introduced in the platform. This approach has been exemplified with the automotive industry, but it is applicable to a wide variety of product development endeavours.

The resilient objects presented in Table 2 possess different performances and costs (for example, a mechanical condenser vs. a Peltier plate). Utilizing a “value model” able to evaluate the lifecycle value of different options could be helpful and effective to decide which resilient object to choose. The value model could also be effective in identifying the benefit of using resilient objects at all. Very flexible and resilient platforms often result in making products that are suboptimized and with lower functionality compared to the case in which the variants are individually designed (Kamrad et al., 2013). Future work will focus on extending the matrix of multi-technological resilient objects, and to define a systematic method to design, select and evaluate which resilient objects are more valuable to be inserted in specific regions of the product platform.

References

- Chalupnik, M. J., Wynn, D. C., & Clarkson, P. J. (2013). Comparison of utilities for protection against uncertainty in system design. *Journal of Engineering Design*, 24(12), 814-829.
- Christopher, M., & Rutherford, C. (2004). Creating supply chain resilience through agile six sigma. *Critical eye*, 7(1), 24-28.
- Clarkson, P. J., Simons, C., & Eckert, C. (2004). Predicting change propagation in complex design. *J. Mech. Des.*, 126(5), 788-797.
- Crawley, E., de Weck, O., Eppinger, S., Magee, C., Moses, J., Seering, W., ... & Whitney, D. (2004). Engineering systems monograph. Massachusetts Institute of Technology, Tech. Rep.
- Bielaczyc, P., & Woodburn, J. (2019). Trends in Automotive Emission Legislation: Impact on LD Engine Development, Fuels, Lubricants and Test Methods: a Global View, with a Focus on WLTP and RDE Regulations. *Emission Control Science and Technology*, 5(1), 86–98. <https://doi.org/10.1007/s40825-019-0112-3>
- de Neufville, R., & Scholtes, S. (2011). Flexibility in engineering design. MIT Press.
- de Neufville, R., de Weck, O., Frey, D., Hastings, D., Larson, R., Simchi-Levi, D., ... & Welsch, R. (2004, March). Engineering systems monograph. In Engineering systems symposium.
- Fiksel, J. (2007). Sustainability and resilience: Toward a systems approach. *IEEE Engineering Management Review*, 35(3), 5-5.
- Fricke, E., & Schulz, A. P. (2005). Design for changeability (DfC): Principles to enable changes in systems throughout their entire lifecycle. *Systems Engineering*, 8(4), no-no.
- Hollnagel, E. 1993. Human Reliability Analysis: Context and Control. London: Academic Press.
- Hollnagel, E., Nemeth, C. P., & Dekker, S. (Eds.). (2008). Resilience engineering perspectives: remaining sensitive to the possibility of failure (Vol. 1). Ashgate Publishing, Ltd..
- Hollnagel, E., Woods, D. D., & Leveson, N. (Eds.). (2006). *Resilience engineering: Concepts and precepts*. Ashgate Publishing, Ltd..
- Hölttä-Otto, K., & De Weck, O. (2007). Degree of modularity in engineering systems and products with technical and business constraints. *Concurrent Engineering*, 15(2), 113-126.
- Beitz, W., Pahl, G., & Grote, K. (1996). Engineering design: a systematic approach. *Mrs Bulletin*, 71.

- Kamrad, B., Schmidt, G.M. and Ülkü, S. (2013), “Analyzing Product Architecture Under Technological Change: Modular Upgradeability Tradeoffs”, *IEEE Transactions on Engineering Management*, Vol. 60 No. 2, pp. 289–300.
- Kreimeyer, M., & Lindemann, U. (2011). *Complexity metrics in engineering design: managing the structure of design processes*. Springer Science & Business Media.
- Lequesne, B. (2015). Automotive Electrification: The Nonhybrid Story. *IEEE Transactions on Transportation Electrification*, 1(1), 40–53. <https://doi.org/10.1109/TTE.2015.2426573>
- Llopis-Albert, C., Rubio, F., & Valero, F. (2021). Impact of digital transformation on the automotive industry. *Technological Forecasting and Social Change*, 162, 120343. <https://doi.org/10.1016/j.techfore.2020.120343>
- McManus, H., & Hastings, D. (2005, July). 3.4. 1 A framework for understanding uncertainty and its mitigation and exploitation in complex systems. In *INCOSE international symposium* (Vol. 15, No. 1, pp. 484-503).
- Meyer, M.H. and Lehnerd, A.P. (1997), *The Power of Product Platforms: Building Value and Cost Leadership.*, Vol. 10020.
- Müller, J. R., Isaksson, O., Landahl, J., Raja, V., Panarotto, M., Levandowski, C., & Raudberget, D. (2019). Enhanced function-means modeling supporting design space exploration. *AI EDAM*, 33(4), 502-516.
- Otto, K., Hölttä-Otto, K., Simpson, T. W., Krause, D., Ripperda, S., & Ki Moon, S. (2016). Global views on modular design research: linking alternative methods to support modular product family concept development. *Journal of Mechanical Design*, 138(7), 071101.
- Pelliccione, P., Knauss, E., Heldal, R., Ågren, S. M., Mallozzi, P., Alming, A., & Borgentun, D. (2017). Automotive architecture framework: The experience of volvo cars. *Journal of systems architecture*, 77, 83-100.
- Pimmler, T. U., & Eppinger, S. D. (1994). Integration analysis of product decompositions. *ASME Design Theory and Methodology Conference*, Minneapolis, MN, September 1994.
- Qureshi, A., Murphy, J. T., Kuchinsky, B., Seepersad, C. C., Wood, K. L., & Jensen, D. D. (2006, January). Principles of product flexibility. In *International Design Engineering Technical Conferences and Computers and Information in Engineering Conference* (Vol. 42584, pp. 295-325).
- Ross, A. M., Rhodes, D. H., & Hastings, D. E. (2008). Defining changeability: Reconciling flexibility, adaptability, scalability, modifiability, and robustness for maintaining system lifecycle value. *Systems engineering*, 11(3), 246-262.
- Sethi, A.K. and Sethi, S.P. (1990), “Flexibility in manufacturing: A survey”, *International Journal of Flexible Manufacturing Systems*, Vol. 2 No. 4, pp. 289–328.
- Simpson, T.W. (2004), “Product platform design and customization: Status and promise”, *Artificial Intelligence for Engineering Design, Analysis and Manufacturing: AIEDAM*, Vol. 18 No. 1, pp. 3–20.
- Siroki, S., Nyerges, Á., & Tihanyi, V. (2019). A review of automated vehicle systems. *2019 International IEEE Conference and Workshop in Óbuda on Electrical and Power Engineering (CANDO-EPE)*, 109–114. <https://doi.org/10.1109/CANDO-EPE47959.2019.9111005>
- Thunnissen, D. P. 2005. “Propagating and Mitigating Uncertainty in the Design of Complex Multidisciplinary Systems”. PhD dissertation, California Institute of Technology.
- Ulrich, K.T. (1995), “The Role of Product Architecture in the Manufacturing Firm”, *Research Policy*, Vol. 24, pp. 419–440.
- Weick, K. E., Sutcliffe, K. M., & Obstfeld, D. (1999). Organizing for high reliability: processes of collective mindfulness” in *Research in Organizational Behaviour*, 21, R.